



DS-1259ZJ

Inclined ceiling mount for DS-2CD21XX dome camera

Features:

- Good toughness and strength
- Beautiful design with wire outlet hole
- Coordination with small and nice appearance
- Angle of elevation is increased by 15°

Dimension:

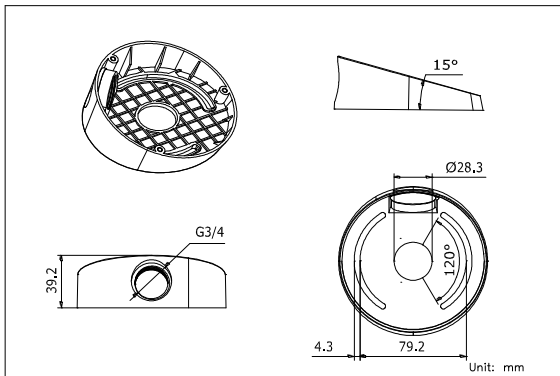

Order model:

DS-1259ZJ

Parameters:

Model	DS-1259ZJ
Parameters	Suitable for DS-2CD21XX series dome cameras
Color	Hik white
Feature	Suitable for DS-2CD21XX series dome cameras Angle of elevation is increased by 15°
Material	ABS+PC
Dimension	Φ111×39.2mm(Φ4.37"×1.54")
Weight	200g(0.44lbs)

Notice:

- This bracket is only for DS-2CD21XX series dome camera
- Pay attention to the application range when select bracket
- Pay attention to the color matching when select bracket
- The bracket should be installed on flat wall
- The wall must be capable of supporting more than 3 times the total load of the camera and the mount.
- The maximum load capacity of the mount is 2.0KG

Installation steps:

- ① Select suitable wall to install the bracket and wire.
- ② Loosen the tightening screw and take down the housing.
- ③ Install the dome core to the gang box, wire and lock the screw.

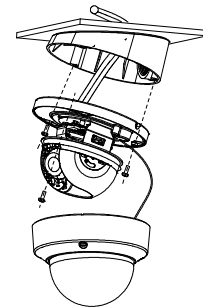
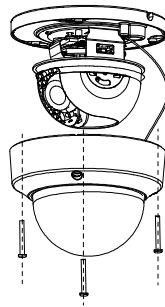
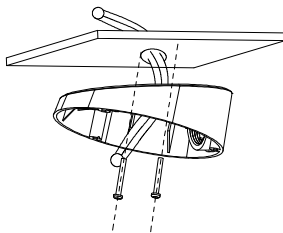

- ④ Adjust the angle through the 3-axis adjustment structure.
- ⑤ Install the housing and lock the screws.
- ⑥ Finish the installation.

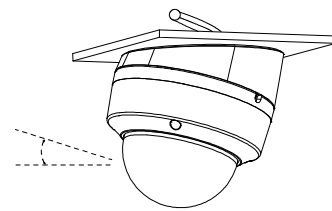
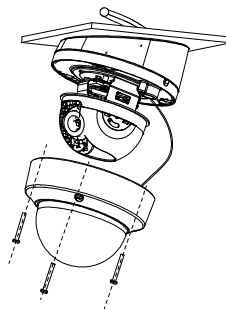
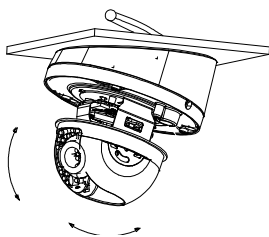

Remark: Appearance of Installation steps is for reference only