



DS-1100KI Network Keyboard
User Manual

TABLE OF CONTENTS

Chapter 1 Introduction	9
1.1 Overview	9
1.2 Features.....	9
1.3 Appearance	10
Chapter 2 Operation Guide.....	12
2.1 User Account	12
2.2 Indicators and Buttons	12
2.3 Button Operation	15
2.3.1 Operating Video Wall Display	15
2.3.2 PTZ Control Buttons	16
2.3.3 Other Buttons.....	16
2.4 Input Method Shift.....	17
2.5 Basic Operation Procedure.....	18
2.6 Quick Configuration Guide	18
2.6.1 Login	18
2.6.2 Settings the Network	19
2.6.3 Managing the Device	20
2.6.4 Managing the User	21
2.7 Quick Operation	22
2.7.1 Multi-Division Display	22
2.7.2 Display of Decoded Video to Output Channel	23
Chapter 3 Local Keyboard Configuration by Admin	24
3.1 Login	24
3.2 Changing the Password	25
3.3 Keyboard Management.....	26
3.3.1 Viewing Version Information	26
3.3.2 Configuring Network.....	27
3.3.3 Configuring Hardware	27
3.3.4 Configuring Time.....	28
3.3.5 Configuring Language.....	29
3.3.6 Calibrating Screen	29
3.3.7 Upgrading Device	30
3.4 Device Management	31
3.4.1 Adding a Device.....	32
3.4.2 Editing/Deleting the Device	33
3.5 User Management.....	34
3.5.1 Adding a User	35
3.5.2 Setting the Related Device	35
3.5.3 Editing/Deleting the User.....	36
3.6 Importing/Exporting Configuration File.....	37
3.7 Restoring to Default Settings.....	38

3.8 Logout	39
3.9 Reboot.....	39
3.10 Shutdown	39
Chapter 4 Local Keyboard Configuration by Operator	40
4.1 Login	40
4.2 Viewing Device List	41
4.3 Encoding Device Settings	42
4.3.1 Network Settings.....	42
4.3.2 Serial Port Settings	43
4.3.3 Camera Settings	43
4.3.4 Alarm Settings	54
4.3.5 Exceptions	56
4.3.6 Maintenance	57
4.3.7 Stream Media Settings	58
4.3.8 Remote Panel Settings	58
4.4 Decoding Device Settings	59
4.4.1 Network Settings.....	59
4.4.2 Serial Port Settings	60
4.4.3 Output Settings	61
4.4.4 Video Wall Settings	61
4.4.5 Viewing Decoding Status	62
4.4.6 Maintenance	63
4.5 Input Settings	63
4.5.1 Starting Local Live View	64
4.5.2 Live View by Channel-Zero.....	64
4.5.3 Editing a Camera	65
4.5.4 Setting Input Group.....	65
4.6 Output Settings	66
4.6.1 Playback on Monitor	67
4.6.2 Playback on Window.....	69
4.6.3 Editing an Output Channel.....	72
4.6.4 Setting Output Group.....	72
4.6.5 Setting Video Wall / Scene.....	73
4.7 Macro Settings	74
4.7.1 Adding Macro	74
4.7.2 Viewing Macro	75
4.7.3 Running Macro	75
4.7.4 Deleting Macro.....	75
4.8 Playback.....	75
4.8.1 Playback by USB File	76
4.8.2 Playback by File	77
4.8.3 Playback by Time	77
4.9 Advanced Settings	78

4.10 Password Settings	78
4.10.1 Auxiliary Key Settings	79
4.10.2 Live View & PTZ Speed Settings	79
4.11 Logout	80
4.12 Reboot	80
4.13 Shutdown	80
Chapter 5 Keyboard Operation	81
5.1 Shortcut Operation.....	81
5.2 Local Live View	81
5.3 Displaying Decoded Video to Output Channel	82
5.3.1 Setting Multi-Division Display	82
5.3.2 Displaying Video to Output Channel.....	83
5.3.3 Displaying Video of Camera Group to Output Channel	85
5.3.4 Displaying Video of Camera Group to the Window of Output Channel.....	85
5.3.5 Displaying Video of Camera Group to Output Group	86
5.3.6 Displaying Video of Camera Group to the Window Group	87
5.3.7 Setting a Tour	88
5.3.8 Calling a Tour	88
5.3.9 Setting a Group Tour	89
5.3.10 Calling a Group Tour	90
5.3.11 Operating Instant Playback	90
5.3.12 Switching Video to the Screen	91
5.3.13 Operating Scene Switch	92
5.4 PTZ Control.....	93
5.4.1 Realizing PTZ Control.....	93
5.4.2 Setting a Preset	93
5.4.3 Calling a Preset	94
5.4.4 Setting a Patrol	95
5.4.5 Calling a Patrol.....	96
5.4.6 Setting a Pattern.....	97
5.4.7 Calling a Pattern	99
5.4.8 Calling Pan Scan.....	100
5.5 Auxiliary Functions	100
5.5.1 Starting Two-Way Audio.....	100
5.5.2 Capturing Picture	101
5.5.3 Recording	101
5.5.4 Wall Switch	102
5.5.5 Other Functions.....	102
5.5.6 Access to and operate 256 NVR	103
Chapter 6 Server Operation	105
6.1 Accessing by MVC.....	105
6.1.1 Login	105
6.1.2 Device List	105

6.1.3 Camera List.....	107
6.1.4 Output Channel List.....	109
6.1.5 Scene Settings	112
6.1.6 Screen Settings.....	113
6.2 Accessing by Analog Matrix.....	118
6.2.1 Login	118
6.2.2 Configuring RS-232 Parameters	119
6.2.3 Operating Analog Matrix.....	119
6.2.4 Configuring RS-485 Parameters	120
6.2.5 Operating PTZ Control	121
6.3 Accessing by Matrix Access Gateway	124
6.3.1 Login	124
6.3.2 Operating Matrix Access Gateway	124
6.3.3 Operating PTZ Control.....	124
6.4 Accessing by iVMS Platform	125
6.4.1 Logging in to the iVMS Platform	125
6.4.2 Managing Input Channel.....	125
6.4.3 Managing Output Channel.....	126
6.4.4 Displaying Video on Video Wall.....	127
6.4.5 Switching the Scene	128
Chapter 7 Keyboard Configuration by WEB Server.....	129
7.1 Configuring by Admin.....	129
7.1.1 Login	129
7.1.2 Keyboard Management.....	130
7.1.3 User Management.....	130
7.1.4 Device Management	133
7.1.5 Importing/Exporting Camera List.....	134
7.1.6 Maintenance	135
7.2 Configuring by Operator.....	136
7.2.1 Login	136
7.2.2 Device Management	137
7.2.3 Input Settings	138
7.2.4 Output Settings	140
7.2.5 AUX Functions	141
7.2.6 Network Performance Settings	141
7.2.7 FTP Server Settings.....	142

UserManual

COPYRIGHT ©2018 Hangzhou Hikvision Digital Technology Co., Ltd.

ALL RIGHTS RESERVED.

Any and all information, including, among others, wordings, pictures, graphs are the properties of Hangzhou Hikvision Digital Technology Co., Ltd. or its subsidiaries (hereinafter referred to be “Hikvision”). This user manual (hereinafter referred to be “the Manual”) cannot be reproduced, changed, translated, or distributed, partially or wholly, by any means, without the prior written permission of Hikvision. Unless otherwise stipulated, Hikvision does not make any warranties, guarantees or representations, express or implied, regarding to the Manual.

About this Manual

This Manual is applicable to DS-1600 Network Keyboard.

The information contained in the Manual is subject to change, without notice, due to firmware updates or other reasons. Please find the latest version in the company website

(<http://overseas.hikvision.com/en/>).

Please use this user manual under the guidance of professionals.

Trademarks Acknowledgement

HIKVISION and other Hikvision’s trademarks and logos are the properties of Hikvision in various jurisdictions. Other trademarks and logos mentioned below are the properties of their respective owners.

Legal Disclaimer

TO THE MAXIMUM EXTENT PERMITTED BY APPLICABLE LAW, THE PRODUCT DESCRIBED, WITH ITS HARDWARE, SOFTWARE AND FIRMWARE, IS PROVIDED “AS IS”, WITH ALL FAULTS AND ERRORS, AND HIKVISION MAKES NO WARRANTIES, EXPRESS OR IMPLIED, INCLUDING WITHOUT LIMITATION, MERCHANTABILITY, SATISFACTORY QUALITY, FITNESS FOR A PARTICULAR PURPOSE, AND NON-INFRINGEMENT OF THIRD PARTY. IN NO EVENT WILL HIKVISION, ITS DIRECTORS, OFFICERS, EMPLOYEES, OR AGENTS BE LIABLE TO YOU FOR ANY SPECIAL, CONSEQUENTIAL, INCIDENTAL, OR INDIRECT DAMAGES, INCLUDING, AMONG OTHERS, DAMAGES FOR LOSS OF BUSINESS PROFITS, BUSINESS INTERRUPTION, OR LOSS OF DATA OR DOCUMENTATION, IN CONNECTION WITH THE USE OF THIS PRODUCT, EVEN IF HIKVISION HAS BEEN ADVISED OF THE POSSIBILITY OF SUCH DAMAGES.

REGARDING TO THE PRODUCT WITH INTERNET ACCESS, THE USE OF PRODUCT SHALL BE WHOLLY AT YOUR OWN RISKS. HIKVISION SHALL NOT TAKE ANY RESPONSIBILITIES FOR ABNORMAL OPERATION, PRIVACY LEAKAGE OR OTHER DAMAGES RESULTING FROM CYBER ATTACK, HACKER ATTACK, VIRUS INSPECTION, OR OTHER INTERNET SECURITY RISKS; HOWEVER, HIKVISION WILL PROVIDE TIMELY TECHNICAL SUPPORT IF REQUIRED.

SURVEILLANCE LAWS VARY BY JURISDICTION. PLEASE CHECK ALL RELEVANT LAWS IN YOUR JURISDICTION BEFORE USING THIS PRODUCT IN ORDER TO ENSURE THAT YOUR USE CONFORMS THE APPLICABLE LAW. HIKVISION SHALL NOT BE LIABLE IN THE EVENT THAT THIS PRODUCT IS USED WITH ILLEGITIMATE PURPOSES.

IN THE EVENT OF ANY CONFLICTS BETWEEN THIS MANUAL AND THE APPLICABLE LAW, THE LATER PREVAILS.

Regulatory Information

FCC Information

Please take attention that changes or modification not expressly approved by the party responsible for compliance could void the user's authority to operate the equipment.

FCC compliance: This equipment has been tested and found to comply with the limits for a Class A digital device, pursuant to part 15 of the FCC Rules. These limits are designed to provide reasonable protection against harmful interference when the equipment is operated in a commercial environment. This equipment generates, uses, and can radiate radio frequency energy and, if not installed and used in accordance with the instruction manual, may cause harmful interference to radio communications. Operation of this equipment in a residential area is likely to cause harmful interference in which case the user will be required to correct the interference at his own expense.

FCC Conditions

This device complies with part 15 of the FCC Rules. Operation is subject to the following two conditions:

1. This device may not cause harmful interference.
2. This device must accept any interference received, including interference that may cause undesired operation.

EU Conformity Statement

 This product and - if applicable - the supplied accessories too are marked with "CE" and comply therefore with the applicable harmonized European standards listed under the EMC Directive 2014/30/EU, the LVD Directive 2014/35/EU, the RoHS Directive 2011/65/EU.

 2012/19/EU (WEEE directive): Products marked with this symbol cannot be disposed of as unsorted municipal waste in the European Union. For proper recycling, return this product to your local supplier upon the purchase of equivalent new equipment, or dispose of it at designated collection points. For more information see: www.recyclethis.info

 2006/66/EC (battery directive): This product contains a battery that cannot be disposed of as unsorted municipal waste in the European Union. See the product documentation for specific battery information. The battery is marked with this symbol, which may include lettering to indicate cadmium (Cd), lead (Pb), or mercury (Hg). For proper recycling, return the battery to your supplier or to a designated collection point. For more information see: www.recyclethis.info

Industry Canada ICES-003 Compliance

This device meets the CAN ICES-3 (A)/NMB-3(A) standards requirements.



Applicable Models

This manual is applicable to the models listed in the following table.

Series	Model
Network Keyboard	DS-1100KI

Symbol Conventions

The symbols that may be found in this document are defined as follows.

Symbol	Description
 NOTE	Provides additional information to emphasize or supplement important points of the main text.
 WARNING	Indicates a potentially hazardous situation, which if not avoided, could result in equipment damage, data loss, performance degradation, or unexpected results.
 DANGER	Indicates a hazard with a high level of risk, which if not avoided, will result in death or serious injury.

Safety Instructions

- Proper configuration of all passwords and other security settings is the responsibility of the installer and/or end-user.
- In the use of the product, you must be in strict compliance with the electrical safety regulations of the nation and region. Please refer to technical specifications for detailed information.
- Input voltage should meet both the SELV (Safety Extra Low Voltage) and the Limited Power Source with 100~240 VAC or 12 VDC according to the IEC60950-1 standard. Please refer to technical specifications for detailed information.
- Do not connect several devices to one power adapter as adapter overload may cause over-heating or a fire hazard.
- Please make sure that the plug is firmly connected to the power socket.
- If smoke, odor or noise rise from the device, turn off the power at once and unplug the power cable, and then please contact the service center.

Preventive and Cautionary Tips

Before connecting and operating your device, please be advised of the following tips:

- Ensure unit is installed in a well-ventilated, dust-free environment.
- Unit is designed for indoor use only.
- Keep all liquids away from the device.
- Ensure environmental conditions meet factory specifications.
- Ensure unit is properly secured to a rack or shelf. Major shocks or jolts to the unit as a result of dropping it may cause damage to the sensitive electronics within the unit.
- Use the device in conjunction with an UPS if possible.
- Power down the unit before connecting and disconnecting accessories and peripherals.
- A factory recommended HDD should be used for this device.
- Improper use or replacement of the battery may result in hazard of explosion. Replace with the same or equivalent type only. Dispose of used batteries according to the instructions provided by the battery manufacturer.

Chapter 1 Introduction

1.1 Overview

DS-1100KI Network Keyboard can be used to control the camera/speed dome, display decoded video on video wall, control matrix, as well as support 1 channel of live view at up to 1080P resolution. Designed with touch screen, it is easy to operate and configure settings.

1.2 Features

Hardware

- 7" TFT touch screen at 800×480 resolution;
- 4-axis joystick;
- Shortcut keys for dome control, setting and calling of preset, patrol and pattern;
- Shortcut keys for playback operation;
- Shortcut keys for input group and output group;
- Shortcut keys for wiper and light control operation.

General

- Administrator and operator user management;
- Support upgrade by U-flash disk;
- Auto searching connected devices in the same network segment;
- Support 3 operators, and each user is allowed to operate 1280 devices;
- Import and export keyboard configuration files;
- Macro command operation;
- Storage of record files and captured pictures to U-flash disk or FTP server;
- Play back record files from the U-flash disk;
- Play back the remote record files by time or by file;
- Two-way audio;
- Support configuration by WEB server;
- Support configuration by the Keyboard Configuration Tool;
- Configuration and control of the MVC system;
- Support control of the analog matrix with the protocol of ZT-1.0, ZT-2.0, EXTRON or CREATOR;
- Control up to 255 analog domes by RS-485 connection;
- Accessible by the platform software;
- Accessible by HikCentral platform;
- Import/export camera list in the format of *.xls*;
- Support image switch of NVR with 256 channels;
- Support High-performance NVR;

- Support Panoramic Network High-definition Intelligent Camera.

Decoding Capability

- Provide 1-ch local decoding;
- Support standard MPEG4, private H.264 and standard H.264 encoding formats;
- Decoding at up to 1080P resolution.

Display of Decoded Video to Output Channel

- Display of decoded camera on selected window of output channel;
- Display of decoded camera group on selected window of output channel;
- Cycle display of decoded camera group to the output channel;
- Cycle display of decoded camera group to the output group;
- Display of video via MVC on video wall.

1.3 Appearance

Refer to Figure 1.1 for the appearance of the operation panel of the keyboard.

Operation Panel

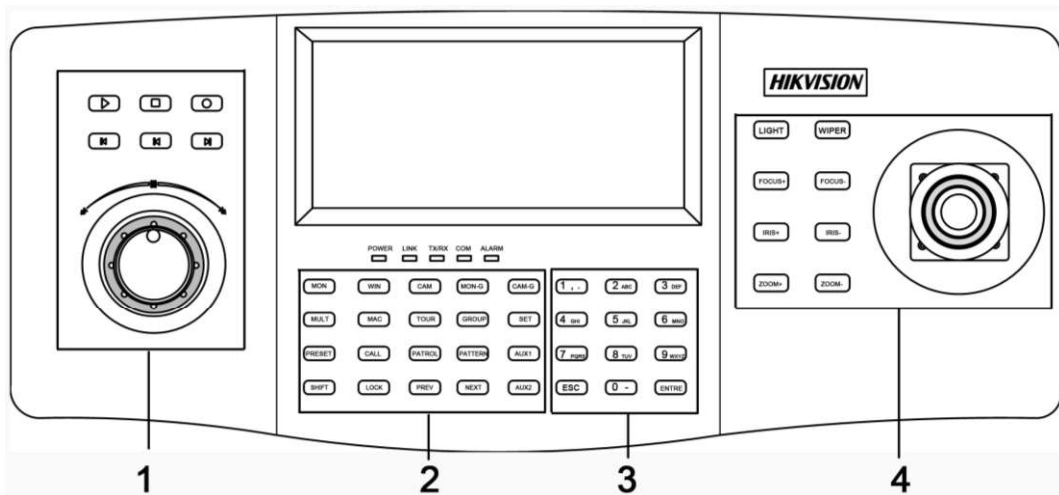

Figure 1.1 Operation Panel

Refer to Table 1.1 for the description of the operation panel.

Table 1.1 Description of Operation Panel

Serial No.	Description	Serial No.	Description
1	Record playback	2	Functional buttons
3	Numeric buttons	4	PTZ control area

Refer to Figure 1.2 for the appearance of the interfaces of the keyboard.

Interfaces

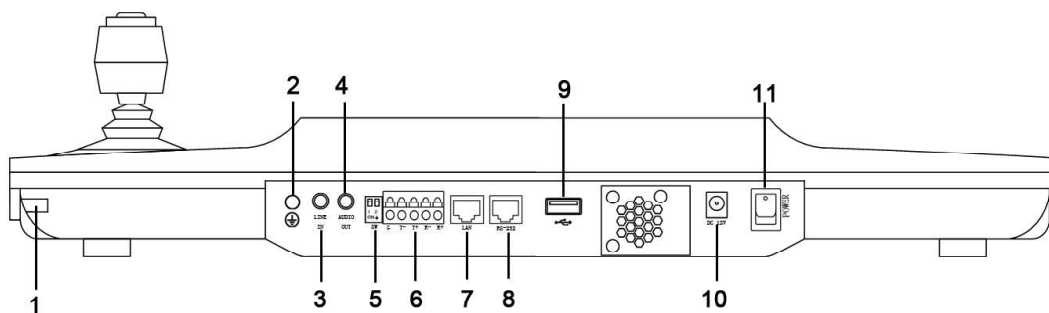

Figure 1.2 Interfaces

Refer to Table 1.2 for the description of the interfaces.

Table 1.1 Description of Interfaces

Serial No.	Description	Serial No.	Description
1	Touch pen	2	GND
3	Line in	4	Audio out
5	Reserved interface	6	RS-485 interface
7	LAN interface	8	RS-232 interface
9	USB interface	10	12 VDC power supply
11	Power on/off		

Chapter 2 Operation Guide

2.1 User Account

The keyboard user account is classified to two types: the **admin** and the **operator**.

The **admin** user is authorized with the following operation permissions:

1. Add a maximum of 3 operators;
2. Configure the keyboard parameters;
3. Add, edit and delete devices;
4. Add, edit and delete users, as well as assign devices for the users;

The **operator** user is allowed to operate the assigned device only;

Up to 1280 devices can be assigned for each operator.

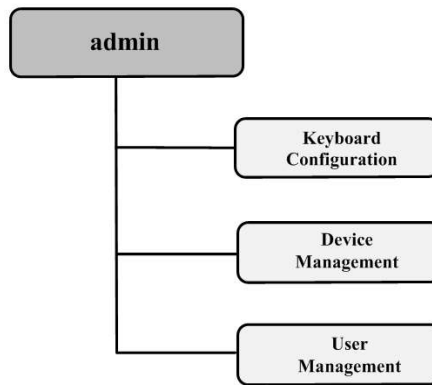

Figure 2.1 Admin Authority

2.2 Indicators and Buttons

Refer to Figure 2.2 for the indicators on the front panel.

Indicators

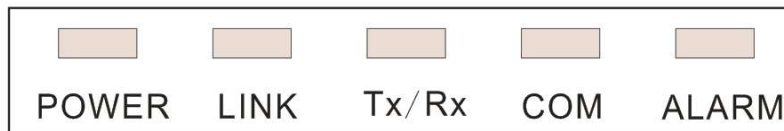

Figure 2.2 Indicators

Refer to Table 2.1 for the description of the indicators.

Table 2.1 Description of LED Indicators

LED Indicator	Description
POWER	Normally lights when the keyboard is powered on.
LINK	Lights when the keyboard is connected with the

	network.
Tx/Rx	Flickers when the keyboard is transmitting/receiving data.
COM	Reserved
ALARM	Reserved

Refer to Figure 2.3 for the functional buttons on the front panel.

Functional Buttons

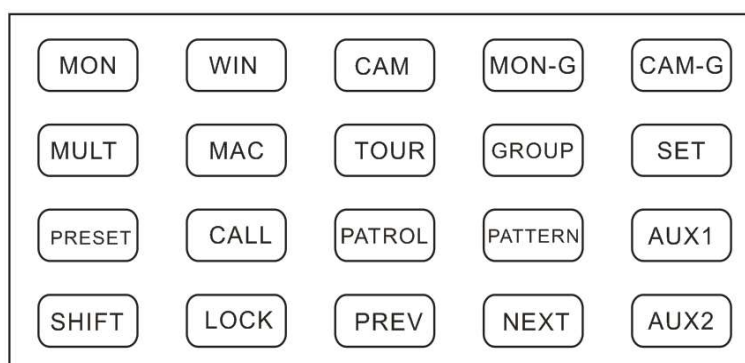

Figure 2.3 Functional Buttons

Refer to Table 2.2 for the description of the functional buttons.

Table 2.2 Description of Functional Buttons

MON	WIN	CAM	MON-G	CAM-G
Select monitor	Select window	Select camera	Select monitor group	Select camera
MULT	MAC	TOUR	GROUP	SET
Multi-division	Call	Set or call tour	Set or call group	Set mode
PRESET	CALL	PATROL	PATTERN	AUX1
Set preset	Call preset	Set or call patrol	Set or call pattern	AUX 1
SHIFT	LOCK	PREV	NEXT	AUX2
Shift	Lock screen	Previous camera	Next camera	AUX2

LOCK Button

The *LOCK* button on the keyboard is used to lock the keyboard and mouse operation. After being locked, it is unallowable to operate all keys (except *LOCK* and *SHIFT*), joystick, mouse and the touch screen.

On any interface or in operation status, you can press and hold the *LOCK* key or press the *SHIFT + LOCK* keys to lock the keyboard operation.

In the lock status, you can press and hold the *LOCK* key or press the *SHIFT + LOCK* keys to unlock the keyboard operation.

NOTE

The keys will be locked as well when the screen is automatically locked.

Numeric Buttons

The numeric buttons are used to input numerals. Refer to Figure 2.4 for the numeric buttons.

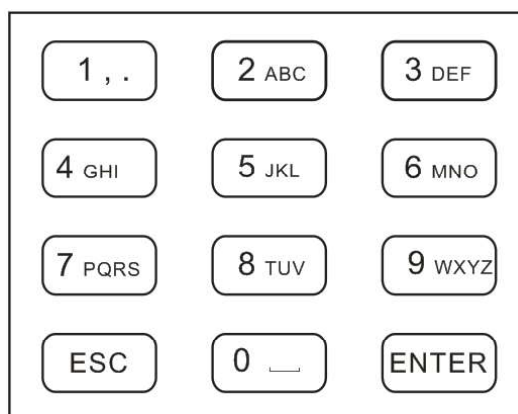

Figure 2.4 Numeric Buttons

4-axis Joystick

Use the joystick to realize pan and tilt movement at 8 directions.

The 4-axis joystick can be used to control the zoom; and the central button is used as Enter button or you can press it to capture picture.



NOTE

The captured pictures can be saved in U-flash disk or uploaded to the FTP server.

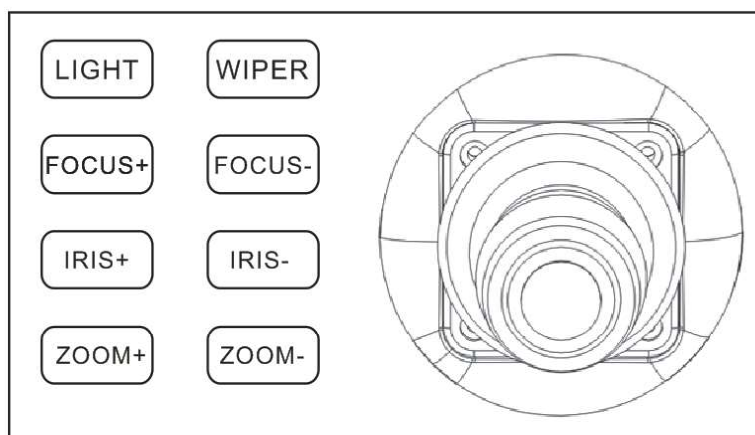

Figure 2.5 Joystick

Playback Control

Rotate the outer ring of shutter in clockwise direction to increase speed, and up to 16X playing speed can be achieved. Rotate the outer ring of shutter in anti-clockwise direction to decrease speed, and 1/16X playing speed can be achieved.

In playback by file, rotate the inner ring of shutter to play the previous/next file.

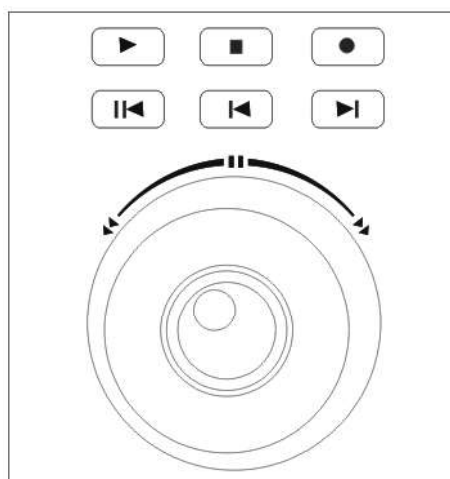

Figure 2.6 Playback Control

Refer to Table 2.3 for the description of playback control.

Table 2.3 Description of Playback Control

	Backward 5min		Stop		Record
	Play/Pause		Previous File		Next File

2.3 Button Operation

2.3.1 Operating Video Wall Display

Refer to Table 2.4 for the description of video wall display buttons.

Table 2.4 Description of Video Wall Display Buttons

Button	Description	Example
MON	<i>Num+MON</i> : select the video output channel to be displayed on the video wall. NOTE When the Num=0, the system enters the local live view mode.	Press the <i>2+MON</i> buttons to select the monitor 2.
MULT	<i>Num+MULT</i> : select different multi-division display modes for the selected output channel.	Press the <i>2+MON+4+MULT</i> buttons to configure 4-division display for the monitor 2.
WIN	<i>Num+MON+Num+WIN+Num+CAM</i> : the video signal from the camera group can be outputted to and displayed on the selected window of monitor in cycle.	Press the <i>2+MON+3+WIN</i> buttons to select the window 3 of the monitor 2.
CAM	<i>Num+CAM</i> : select the video input.	Press the <i>2+MON+3+WIN+5+CAM</i> buttons to display the video input 5 on the window 3 of monitor 2.

MON-G	<i>Num+MON-G</i> : select the monitor group.	Press the <i>1+MON-G</i> buttons to select the monitor group 1.
CAM-G	<i>Num+CAM-G</i> : select the camera group.	Press the <i>1+MON+1+CAM-G</i> buttons to select the camera group 1 to be displayed on the monitor 1.
SET	<i>SET+Num+TOUR/GROUP/PATROL/PATTERN</i> : set the tour, group, patrol and pattern.	Press the <i>SET+1+PATTERN</i> buttons to set the pattern 1.
TOUR	<i>SET+Num+TOUR</i> : set the tour. <i>Num+TOUR</i> : call the defined tour.	Press the <i>SET+1+TOUR</i> buttons to set the tour 1. Press the <i>1+TOUR</i> buttons to call the pre-defined tour 1.
GROUP	<i>SET+Num+GROUP</i> : set the group. <i>Num+GROUP</i> : call the defined group.	Press the <i>SET+1+GROUP</i> buttons to set the group 1. Press the <i>1+GROUP</i> buttons to call the defined group 1.

2.3.2 PTZ Control Buttons

Refer to Table 2.5 for the description of PTZ control buttons.

Table 2.5 Description of PTZ Control Buttons

Button	Description	Example
PRESET	<i>Num+PRESET</i> : move the pan/tilt/zoom to the desired position, and then press the <i>Num+PRESET</i> buttons to set the preset.	Press the <i>1+PRESET</i> buttons to set the preset 1.
CALL	<i>Num+CALL</i> : call the defined preset.	Press the <i>1+CALL</i> buttons to call the preset 1.
PATROL	<i>SET+Num+PATROL</i> : set the patrol. <i>Num+PATROL</i> : set the defined patrol.	Press the <i>SET+1+PATROL</i> buttons to set the patrol 1. Press the <i>1+PATROL</i> buttons to call the patrol 1.
PATTERN	<i>Num+PATTERN</i> :	Press the <i>SET+1+PATTERN</i> buttons to set the pattern 1. Press the <i>1+PATTERN</i> buttons to call the pattern 1.

2.3.3 Other Buttons

Refer to Table 2.6 for the description of other buttons.

Table 2.6 Description of Other Buttons

Button	Description	Example
MAC	<i>Num+MAC</i> : call the MAC command.	Press the <i>1+MAC</i> buttons to call the MAC command 1.
SHIFT	<i>SHIFT+LOCK</i> : lock/unlock the system.	Press the <i>SHIFT+LOCK</i> buttons to

		lock/unlock the system.
LOCK	Lock/unlock the system.	Press and hold the <i>LOCK</i> button or press the <i>SHIFT+LOCK</i> buttons to lock/unlock the system.
PREV	Select the previous camera for live view on keyboard or on TV wall.	
NEXT	Select the next camera for live view on keyboard or on TV wall.	
AUX1	Press the AUX1 button to realize its defined function (two-way audio, picture capture or vide wall/scene switch).	
AUX2	Press the AUX2 button to realize its defined function (two-way audio, picture capture or vide wall/scene switch).	

2.4 Input Method Shift



Tap the  icon on the soft keyboard to enter the interface for inputting the English letters, and the  icon can be used to switch the uppercase/lowercase.



Figure 2.1 English Input Method

Tap the  icon on the soft keyboard to enter the interface for inputting the numerals.



Figure 2.2 Numeric Input Method

2.5 Basic Operation Procedure

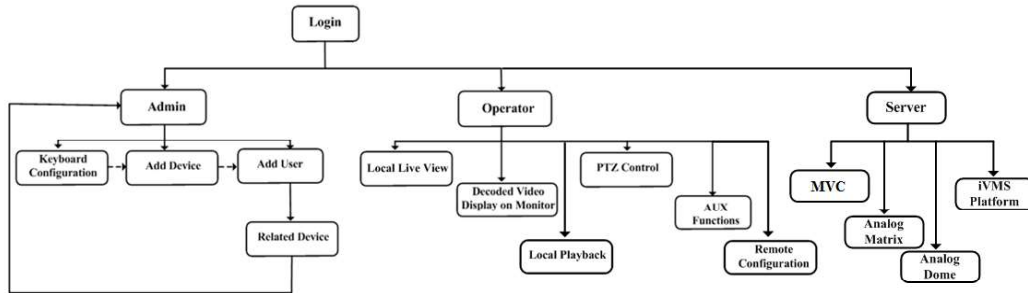

Figure 2.7 Basic Operation Procedure

Admin: For the first time to operate the keyboard, you should configure the keyboard parameters in Keyboard Configuration menu, add device and *operator*, and then link the added device to the assigned *operator*.

Operator: The *operator* is allowed to operate local live view, remote configuration of encoder/decoder parameters, display of decoded video to output channel, local playback, PTZ control, AUX functions, etc.

Server: Control the MVC, analog matrix, and iVMS platform.

2.6 Quick Configuration Guide

Purpose:

You can follow the steps below to complete the quick configuration of the keyboard.

2.6.1 Login

Steps:

1. When the keyboard starts up, it enters the following interface.



Figure 2.8 Startup Interface

2. For basic keyboard operation, tap the **Keyboard** icon to continue and enter the login interface.



Figure 2.9 User Login

3. Select **admin** on the login interface and then input the admin password (default: 12345) to enter the admin interface of keyboard operation. The admin password can be changed and you are highly recommended to change the default password. For detailed default password change, please refer to [Chapter 3.2 Changing the Password](#).

STRONG PASSWORD RECOMMENDED—We highly recommend that you create a strong password of your own choosing (using a minimum of 8 characters, including upper case letters, lower case letters, numbers, and special characters) in order to increase the security of your product. We recommend that you reset your password regularly, especially in the high security system, resetting the password monthly or weekly can better protect your product.



Figure 2.10 Admin Main Interface

2.6.2 Settings the Network

Steps:

1. Enter the **Network Settings** interface.
Keyboard > Network
2. Configure the network settings of the keyboard, including the **Port**, **IP Address**, **Subnet Mask**, **Default Gateway**, **Preferred DNS**, **Alternate DNS** and **MAC Address**. Tap **Apply** to save the settings.

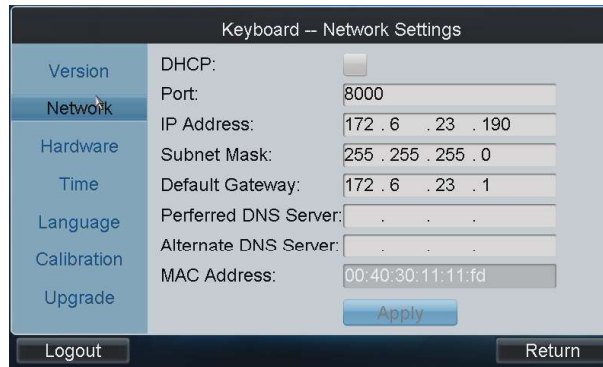

Figure 2.11 Network Settings

3. Tap **Return** to return to the main interface.

2.6.3 Managing the Device

Steps:

1. Tap **Device** on the **admin** main interface to enter the **Device Management** interface.
2. Tap **Add Device** to enter the **Device-Add Device** interface. Input the device name, device IP/domain name, port, user name and password, and then tap **Add** to add the device.



Figure 2.12 Add Device

3. Return to the **Device-Device List** interface, and the successfully added device is shown on the list. You can add device in the three sheets including **Encoder** list for adding encoding devices such as IP camera, DVR, NVR, etc. , **Controller** list for adding controlling devices such as video wall controller, etc. and **Decoder** list for adding decoding devices. Tap **Return** to return to the main interface.

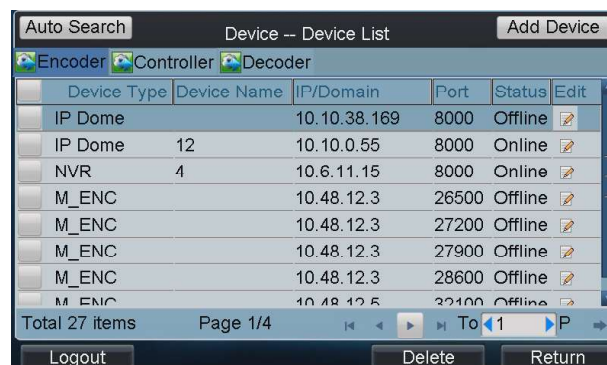

Figure 2.13 Device List

2.6.4 Managing the User

Steps:

1. Tap **User** on the main interface to enter the **User-User List** interface.

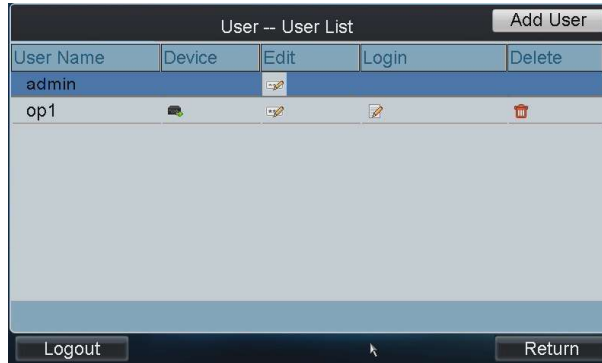

Figure 2.14 User List

2. On the **User List** interface, tap **Add User** to enter the **Add User** interface. Input the user name, password and confirm the password. Tap **Add** to finish the adding of user.



Figure 2.15 Add User

3. Return to the **User List** interface, and tap  of the selected user to enter the **User-Device** interface.



Figure 2.16 Device

4. Tap **Add Device** to enter the **User-Add Device** interface. Select the device by checking the checkbox, and tap **Add** to add the device for the current user.



Figure 2.17 Add Device

5. The added device (s) for the current user can be displayed on the **User-Device** interface.
6. You can directly tap the  (Login) icon of a user to switch to its operation interface. Or you can tap **Logout** on the **admin** main interface and the message box “Logout Now?” will pop up. Tap **Yes** to confirm the logout, or **No** to cancel the operation.



Figure 2.18 User List

2.7 Quick Operation

Purpose:

The *Operator* user is allowed to select different multi-division display modes for the selected output channel and display the decoded video on the selected window of the output channel. The following quick operations are two examples. For all the quick operations of the keyboard, refer to the Chapter 5 Keyboard Operation.

2.7.1 Multi-Division Display

Steps:

1. Press the *Num + MON* keys to select the output channel.
2. Press the *Num + MULT* keys to select the multi-division display mode for the selected output channel.

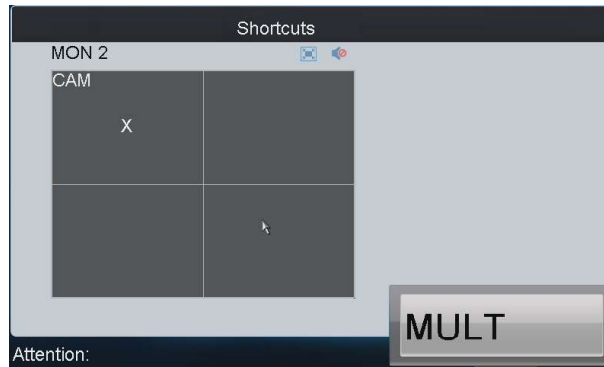

Figure 2.19 Multi-Division Display

2.7.2 Display of Decoded Video to Output Channel

Steps:

1. Press the *Num + MON* keys to select the output channel.
2. Press the *Num + WIN* keys to select the display window of the output channel.
You can also directly touch the screen to select the display window.
3. Press the *Num + CAM* keys to select the input camera.

You can also deselect the display of the input camera by pressing *0 + CAM*.

For example: You can press the “*1+MON, 2+WIN, 3+CAM*” keys to decode the video signal from camera 3 and display it on window 2 of output channel 1.

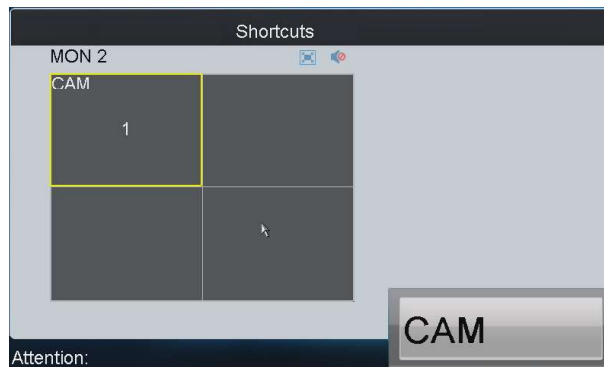

Figure 2.20 Display Video to Output Channel

Chapter 3 Local Keyboard Configuration by Admin

Purpose:

As an *admin*, you can configure the keyboard locally, or by WEB page. This chapter introduces the local keyboard configuration by the *admin*.

3.1 Login

Steps:

1. Tap the **Keyboard** icon on the startup interface.

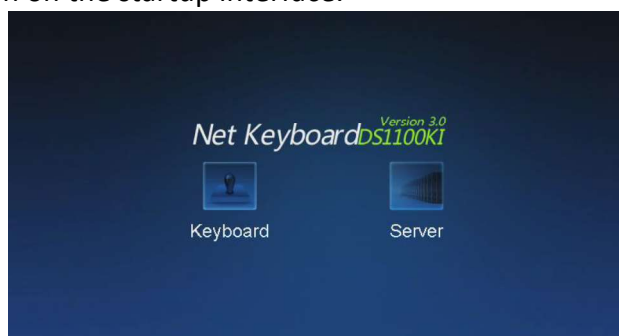

Figure 3.1 Startup Interface

2. Select *admin* on the login interface. Remain the password empty.



Figure 3.2 User Login

3. Tap **Login** and the Activation window will pop out to remind you to reset the password.



Figure 3.3 Activation

STRONG PASSWORD RECOMMENDED—We highly recommend that you create a strong

password of your own choosing (using a minimum of 8 characters, including upper case letters, lower case letters, numbers, and special characters) in order to increase the security of your product. We recommend that you reset your password regularly, especially in the high security system, resetting the password monthly or weekly can better protect your product.

4. Input the New Password and Confirm the password. Tap **OK** to return to the **Login** interface.
5. Input the new password. Check the checkbox of Remember Password if you need.
6. Tap **Login** to enter the main interface of *admin*.



Figure 3.4 Admin Main Interface

 **NOTE**

For the *admin*, if you have input the wrong password for 7 times, the keyboard will be locked for 30 minutes.

3.2 Changing the Password

Purpose:

You can change the password of the *admin*.

Steps:

1. After entering the main interface, tap **User** to enter **User-User List** interface. Tap  to change the default password.

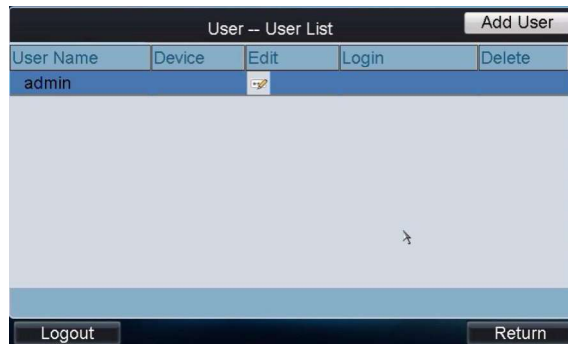

Figure 3.5 User List

2. Input the Current Password and New Password and confirm the New Password.



Figure 3.6 Change Password

If the password you set is too simple, the message box as shown in Figure 3.5 will pop out to remind you to reset the password.

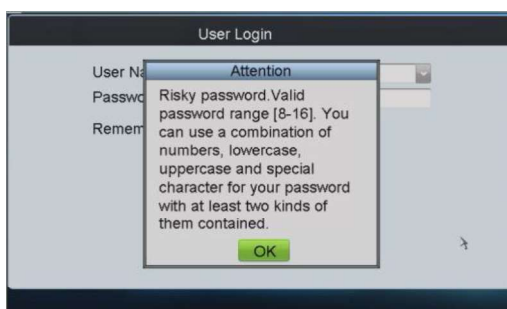

Figure 3.7 Risky Password Attention

If the password you set is weak, the message box “Weak password” will pop out, but you are able to finish the password settings.

3. Tap **OK** to finish the password changing.

3.3 Keyboard Management

Purpose:

On the main interface of *admin*, tap the **Keyboard** on the left navigation bar to enter the Keyboard Management interface. In the Keyboard Management interface, you can view the device version information, configure network parameters, configure hardware settings, adjust time, select language, calibrate the screen and upgrade system.

3.3.1 Viewing Version Information

Tap **Version** to enter the **Keyboard-Version** interface to view the current version information of the keyboard.



Figure 3.8 Version Information

3.3.2 Configuring Network

Steps:

1. Tap **Network** to enter the **Keyboard-Network Settings** interface.
2. Configure the network settings of the keyboard, including the Port, IP address, Subnet Mask, Default Gateway, Preferred DNS, Alternate DNS and MAC Address.
3. Tap **Apply** to save the settings.



NOTE

Make sure the DHCP is supported by the router before enabling the function.



Figure 3.9 Network Settings

3.3.3 Configuring Hardware

Steps:

1. Tap **Hardware** to enter the **Keyboard-Hardware Settings** interface.
2. Configure the Sound Effect, Alarm Sound, Key Light, Keyboard Lock Delay, Screen Off Delay, Background Contrast, Mouse Speed and Screen Brightness.

Sound Effect/Alarm Sound/Key Light: Check the corresponding checkbox to to enable the function, or remain it as to disable the function.

Keyboard Lock Delay/Screen Off Delay: Use the or to decrease or increase the keyboard lock timeout and the screen-close timeout, with the range of 0~10 minute (s) configurable. When the value is set to 0, the keyboard and screen will be unlocked.

Background Contrast: Tap  to select the value from the drop-down menu, with the 3: 1, 1: 1, 1: 3 and *non-transparent* optional.

 **NOTE**

The Background Contrast refers to the contrast of the local decoded video and menu, and is valid only for the local live view.

Mouse Speed: Select the mouse speed from level 0 to 3.

Screen Brightness: Select the screen brightness from level 0 to 4.

3. Tap **Apply** to save the settings.



Figure 3.10 Hardware Settings

3.3.4 Configuring Time

Steps:

1. Tap **Time** to enter the **Keyboard-Time Settings** interface.
2. Set the Date and Time.

Date: Tap  to select the date from the calendar.

Time: Tap  or  to decrease or increase the time value.

3. Tap **Apply** to save the settings.

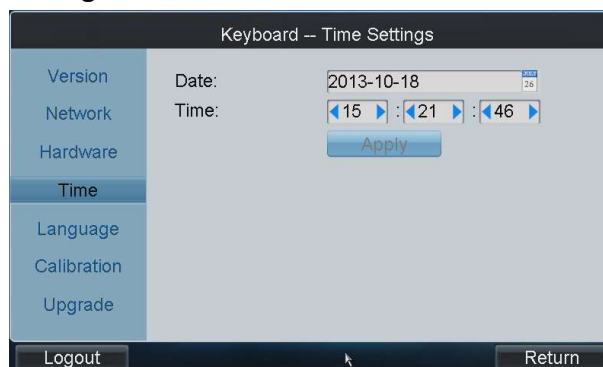



Figure 3.11 Time Settings

3.3.5 Configuring Language

Steps:

1. Tap **Language** to enter the **Keyboard-Language Settings** interface.
2. Tap  to select English as the system language.
3. Tap **Apply** to save the setting.

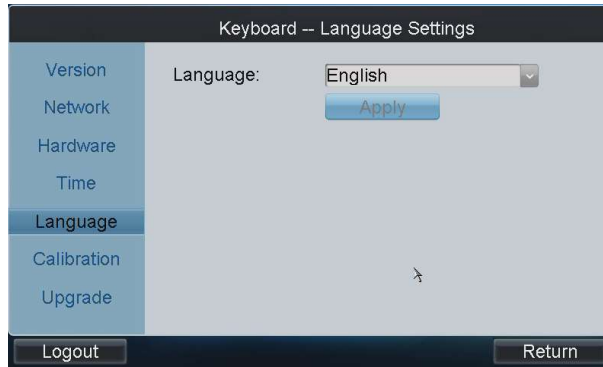

Figure 3.12 Language Settings

3.3.6 Calibrating Screen

Purpose:

In order to use the touch screen correctly, it needs to calibrate the screen positioning properly.

Steps:

1. Tap **Calibration** to enter the **Keyboard-Screen Calibration** interface.
2. Tap **Calibration** to start the calibration of touch screen positioning.

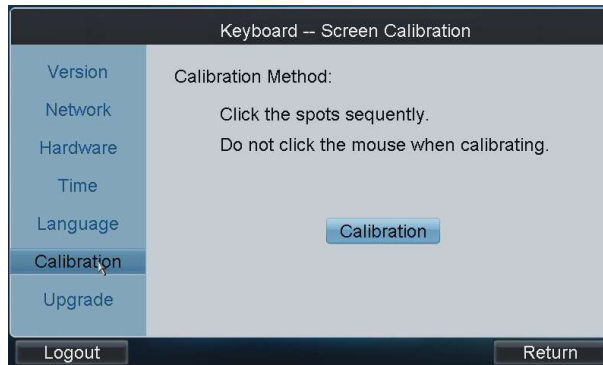

Figure 3.13 Screen Calibration

3. The system will pop up the hint message box. Tap **Yes** to continue the calibration.



Figure 3.14 Hint Box

4. Use the touch pen to tap the three spots marked as “+” by following the hints.

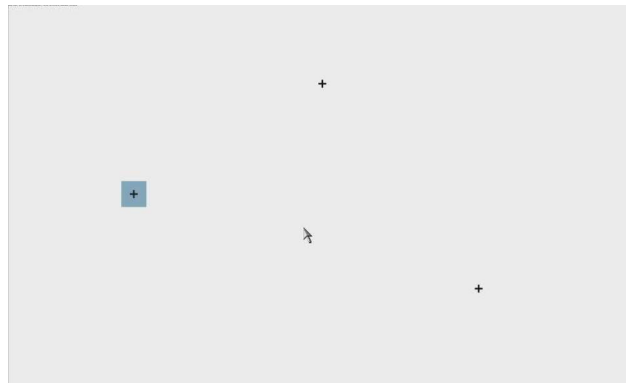

Figure 3.15 Tap the Spots

5. The system will pop up the hint “Screen calibration completed.”. Tap **OK** to finish the operation.



Figure 3.16 Hint Box

3.3.7 Upgrading Device

Tap **Upgrade** to enter the **Keyboard-Upgrade** interface.

Option 1: Upgrading by FTP

1. Input the address of the FTP server and then tap **FTP Upgrade** to operate the upgrade.



You must create the FTP server connection first by TFTP or WFTP in PC before operating the FTP upgrade. Please refer to [Chapter 8.2 Upgrade by FTP](#) for the upgrading.



Figure 3.17 Upgrade by FTP

2. If the upgrading is failed, the corresponding error message box will pop up.



Figure 3.18 Hint Box

 **NOTE**

When the upgrading is successful, the keyboard will restart automatically to complete the upgrade.

Option 2: Upgrading by USB Flash Disk

Steps:

1. Insert the USB flash disk to the USB interface and then tap **USB Upgrade** to enter the USB Upgrade interface.
2. Select the upgrade file from the disk and tap **Upgrade** to start upgrading.

 **NOTE**

The upgrade file must be in the format of *digicap.dav*.

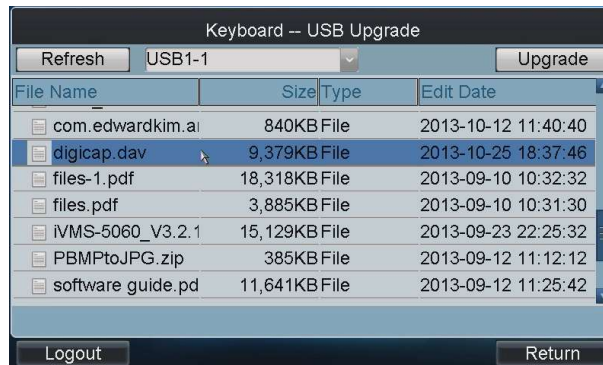

Figure 3.19 USB Upgrade

3. If the upgrading is failed, the corresponding error message box will pop up.

 **NOTE**

When the upgrading is successful, the keyboard will restart automatically to complete the upgrade.

Option 3: Upgrading by WEB Browser

You can refer to [Chapter 7.1.6 Maintenance](#) for the steps of upgrading by WEB browser.

3.4 Device Management

Purpose:

You can add, edit and delete devices in Device Management interface. Three kinds of devices can be added. **Encoder** list for adding encoding devices such as IP camera, DVR, NVR, etc. , **Controller** list for adding controlling devices such as video wall controller, etc. and **Decoder** list for adding

decoding devices.

Tap **Device** on the *admin* main interface to enter the **Device-Device List** interface.



Figure 3.20 Device Management



For the B20 MVC, video wall controller, and decoders (such as DS-6400HDI-T, DS-6400HDI-S series decoders) added to the device list, they are named in the format of *Segment No._Device Name*. The segment No. should be the integral multiple of 1000. It will increase progressively according to the added order.

3.4.1 Adding a Device

Task1: Adding Device by Auto Search

Steps:

1. Tap **Auto Search** button at the upper left corner to enter the **Device-Auto Search** interface.



Only the device that is in the same network segment with the keyboard can be searched out by the keyboard.

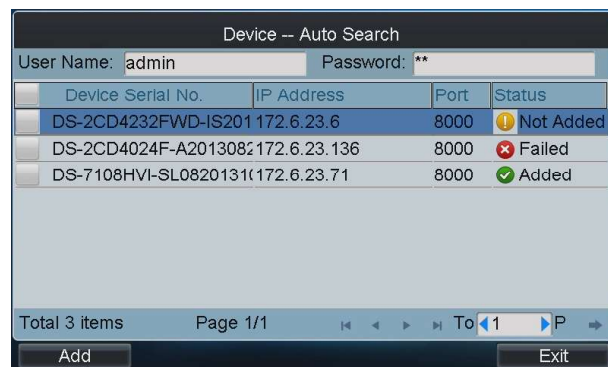





Figure 3.21 Auto Search

2. After the searching is completed, the information of the searched devices will be displayed in the list. Check the checkbox of the device from the list, and then input the login user name and password.
3. Tap **Add** to add the selected device.

 **NOTE**

- Message boxes like “Risky password”, “Weak password”, “Middle password” and “Strong password” will pop out as prompts, and you are allowed to finish the device adding.
- If you have input incorrect user name or password, the hint box of “User name or password is incorrect.” will pop up.
- You can also select multiple devices to be added at a time if they have the same login user name and password by checking the checkboxes in front of them.
- In the status bar, the icon  indicates the device is not added,  indicates the device is failed to be added, and the  indicates the device is successfully added.

4. After having added the devices, tap **Exit** to return to the **Device-Device List** interface, and you can view the information of added devices.

Task2: Adding Device Manually

Steps:

1. Tap **Add Device** to enter the **Device-Add Device** interface. Input the Device Name, device IP, Port, User Name and Password. Select the protocol type.



Figure 3.22 Add Device Manually

2. Tap **Add** to add the device

 **NOTE**

If the input message is incorrect or the device is offline, the message box “Adding Device failed” will pop up.

3.4.2 Editing/Deleting the Device

Editing Device

Steps:

1. On the **Device-Device List** interface, tap  of the device from the list to be edited and enter the **Device-Edit Device** interface.
2. Edit the device name, user name, password and protocol.



Figure 3.23 Edit the Device

 **NOTE**

- If the password is too simple, a message box “Risky password” will pop out to remind you the password is unsafe, and you have to reedit the password.
- Message boxes like “Weak password”, “Middle password” and “Strong password” will pop out as prompts.
- Device IP and port are unable to edit on this interface.
- The user name and password here refer to the one used for logging in the device from keyboard.

3. Tap **Edit** to edit the device information.

Deleting Device

Steps:

1. On the **Device-Device List** interface, check the checkbox of the device from the list to be deleted.
2. Tap **Delete** to delete it. In the pop-up message box, tap **Yes** to finish the deletion or **No** to cancel the deletion.

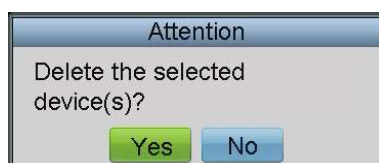

Figure 3.24 Delete the Device

3.5 User Management

Purpose:

You can add, edit and delete the user and assign devices to the added user in User Management interface.

Tap **User** on the *admin* main interface to enter the **User-User List** interface.

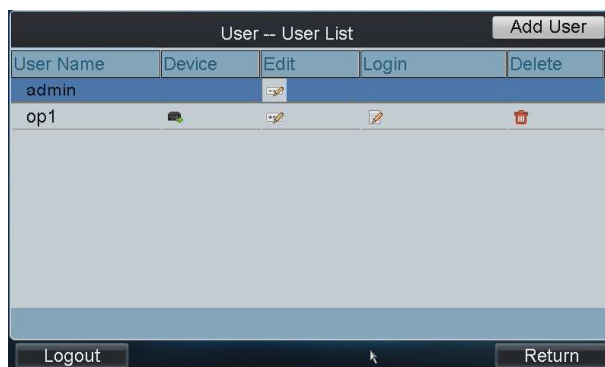

Figure 3.25 User Management

3.5.1 Adding a User

Steps:

1. Tap **Add User** to enter the **User-Add User** interface.



Figure 3.26 Add User

2. Input the User Name, Password and confirm the Password.

 **NOTE**

- If the password is too simple, a message box “Risky password” will pop out to remind you the password is unsafe, and you have to reset the password.
- Message boxes like “Weak password”, “Middle password” and “Strong password” will pop out as well when setting corresponding passwords, and you are allowed to finish user adding.

3. Tap **Add** to finish the adding of user.

3.5.2 Setting the Related Device

Purpose:

For the added operators, they do not have the permission of adding devices. Perform the following procedures to relate devices to the operators by *admin*.

- **Adding a Device**

Steps:

1. On the **User-User List** interface, tap  to enter the **User-Device** interface.



Figure 3.27 Device Interface

2. Select the *operator* from the **Operator** drop-down list.
3. Tap **Add Device** to enter the **User-Add Device** interface. Select the device by checking the checkbox, and tap **Add** to add the device for the current user.



Figure 3.28 Add Device

4. Tap **Exit** and the successfully added devices are listed on the **User-Device** interface.

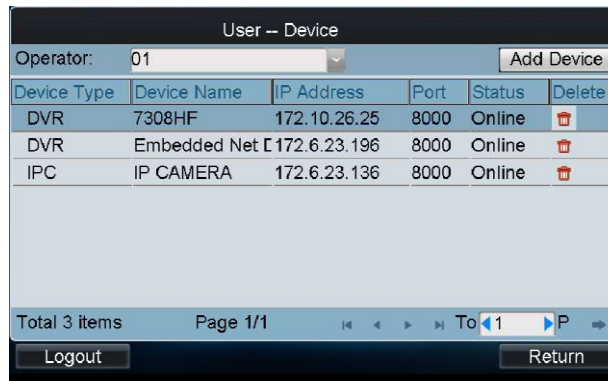



Figure 3.29 Added Device List

- **Deleting a Device**

Enter the **User-Device** interface, you can select the device from the list and tap  to delete the related device for the current user. In the pop-up message box, tap **Yes** to confirm the deletion.

3.5.3 Editing/Deleting the User

- **Editing the User**

Steps:

1. On the **User-User List** interface, tap  to enter the Change Password interface.



Figure 3.30 Change Password for the *Operator*

2. Input the Current Password, New Password and confirm the New Password for the *admin*. Input the New Password and confirm the New Password for the *operator*

 **NOTE**

- If the password is too simple, a message box “Risky password” will pop out to remind you the password is unsafe, and you are not allowed to continue the password settings.
- Message boxes like “Weak Password”, “Middle password” and “Strong password” will pop out when setting corresponding passwords and you are allowed to finish the password settings.

3. Tap **OK** to finish changing the password.

- **Deleting the User**

On the **User-User List** interface, tap  to delete the selected user.

3.6 Importing/Exporting Configuration File

Purpose:

The configuration files of the device can be exported to local device for backup; and the configuration files of one device can be imported to multiple devices if they are to be configured with the same parameters.

Tap **Config file** on the *admin* main interface to enter the Export/Import Configuration File interface.



Figure 3.31 Export/Import Configuration File

- **Importing Configuration File**

Steps:

1. Insert the USB flash disk to the USB interface on the keyboard.
2. Select the configuration file from the disk.
3. Tap **Import** to import the configuration file.



Figure 3.32 Import Configuration File



NOTE

If the imported configuration file is incorrect, the message box “Importing file failed: file type mismatched” will pop up.

- **Exporting Configuration File**

Steps:

1. Insert the USB flash disk to the USB interface on the keyboard.
2. Tap **Export** to export the configuration file named in *kbCfg.bin*.



Figure 3.33 Export Configuration File

3.7 Restoring to Default Settings

Purpose:

There are two restoring types supported: Simple and Complete.

- **Simple:** Remain the password of *admin* and network parameters, and restore other parameters to default.
- **Complete:** Restore all the parameters of the keyboard to default and the keyboard will return to inactive state.

Steps:

1. Tap **Default** on the *admin* main interface.
2. Select restoring type in the pop-up menu.



Figure 3.34 Restore to Default Settings

3. Tap **Yes** to continue the operation, or **No** to cancel the operation.

3.8 Logout

Steps:

1. Tap **Logout** on the *admin* main interface, and the message box "Logout now?" pops up.



Figure 3.35 Logout

2. Tap **Yes** to confirm the logout, or **No** to cancel the operation. After logout, the system will return to the User Login interface.

3.9 Reboot

Steps:

1. Tap **Reboot** on the *admin* main interface, and the message box "Reboot now?" will pop up.



Figure 3.36 Reboot

2. Tap **Yes** to confirm the reboot, or **No** to cancel the operation.

3.10 Shutdown

Steps:

1. Tap **Shutdown** on the *admin* main interface, and the message box "Shut down now?" will pop up.



Figure 3.37 Shutdown

2. Tap **Yes** to confirm the shutdown, or **No** to cancel the operation.

Chapter 4 Local Keyboard Configuration by Operator

Purpose:

As an *operator*, you can configure the keyboard locally, or by WEB page. This chapter introduces the local keyboard configuration by the *operator*.

4.1 Login

Purpose:

You can log in to the *operator* main interface in two ways.

- **Option 1:**

Steps:

1. On the **User Login** interface, select the User Name (*operator*) and input the password.
2. If needed, check the checkbox of Remember Password to save the login password for future use.
3. Tap **Login** to enter the *operator* main interface.



Figure 4.1 Operator Login (1)

NOTE

For the *operator*, if you have input the wrong password for 5 times, the keyboard will be locked for 30 minutes.

- **Option 2:**

Steps:

1. On the **User-User List** interface of the *admin*, tap  (Login Operator) to directly switch to the *Operator* User Login interface.

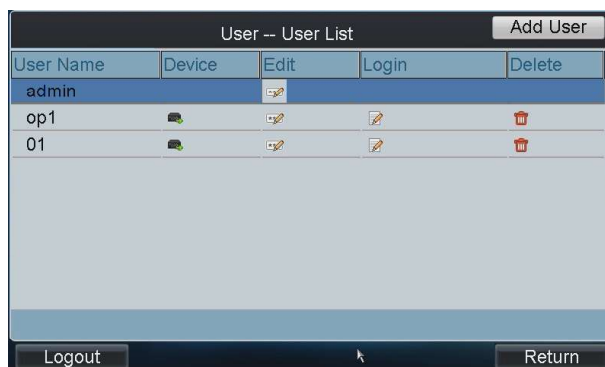

Figure 4.2 Operator Login (2)

2. Tap **Yes** to log in to the *operator* main interface.

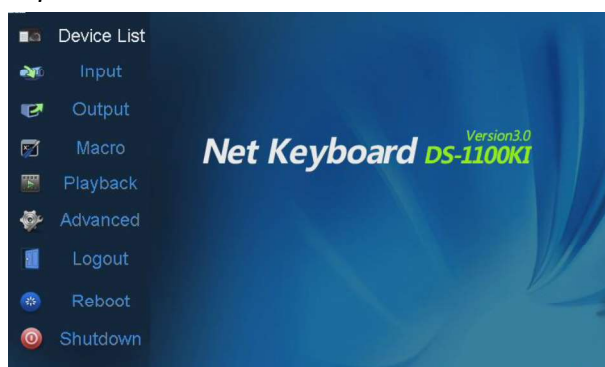

Figure 4.3 Operator Main Interface

4.2 Viewing Device List

Tap **Device List** on the main interface to enter the **Device List** interface. The list displays all devices which can be controlled by the current login user. Three kinds of devices are listed. **Encoder** list for adding encoding devices such as IP camera, DVR, NVR, etc. , **Controller** list for adding controlling devices such as video wall controller, etc. and **Decoder** list for adding decoding devices..



Figure 4.4 Device List

NOTE

For the B20 MVC, video wall controller, and decoders (such as DS-6400HDI-T, DS-6400HDI-S series decoders) added to the device list, they are named in the format of *Segment No._Device Name*.

The segment No. should be the integral multiple of 1000. It will increase progressively according to the added order.

4.3 Encoding Device Settings

Purpose:

You can configure the settings for network, RS-232/RS-485 serial port, camera, alarm, exception, stream media, remote panel etc. of the encoding devices.

Tap  of an encoding device on the **Device List** interface and enter its **Remote Settings** interface.

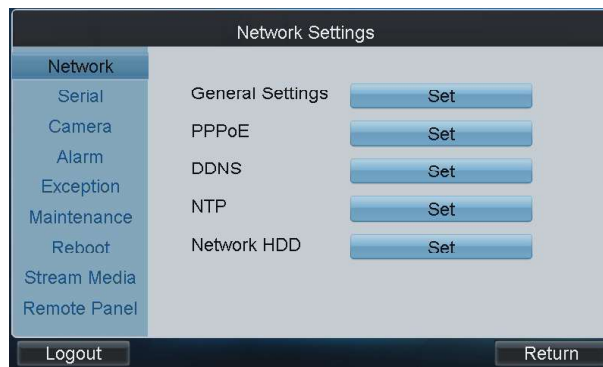

Figure 4.5 Remote Settings Interface

4.3.1 Network Settings

Steps:

1. Tap **Network** on the **Remote Settings** interface to enter the **Network Settings** interface.

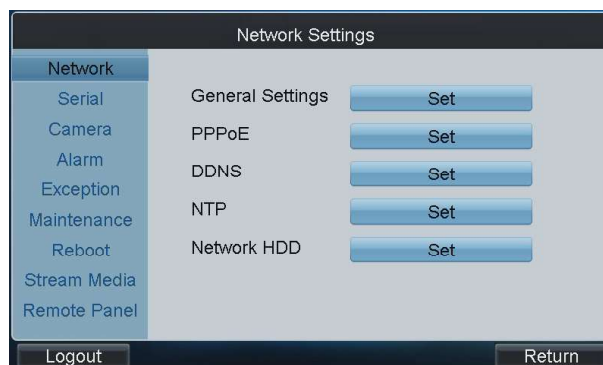

Figure 4.6 Network Settings

2. You can enter the following settings interface to configure the network parameters.
 - **General Settings:** Configure the NIC type, IP address, port, gateway, subnet mask, MAC address, DNS server address, and HTTP port of the current input device.
 - **PPPoE:** Enable PPPoE, and configure the user name and password of PPPoE settings.
 - **DDNS:** Enable DDNS, select the protocol type to IP Server, DynDns, PeanutHull or NO-IP, and configure the corresponding settings.
 - **NTP:** Enable NTP and configure NTP settings to synchronize the time of device to the selected

time zone.

- **Network HDD:** Set the server IP address, file path and type of the network HDD to use.

4.3.2 Serial Port Settings

Steps:

1. Tap **Serial** on the **Remote Settings** interface to enter the **Serial Port Settings** interface.



Figure 4.7 Serial Port Settings

2. Tap **Set** to set the RS-232 and RS-485 port parameters.



Figure 4.8 RS-232Settings



Figure 4.9 RS-485 Settings

4.3.3 Camera Settings

Steps:

1. Tap **Camera** on the **Remote Settings** interface to enter the **Camera Settings** interface.



Figure 4.10 Camera Settings

2. You can configure the OSD settings, video parameters, record settings, motion detection, video loss detection, tampering alarm, privacy mask, and IPC management (for hybrid DVR and NVR only).

Configuring OSD Settings

Steps:

1. Tap **Set** of the OSD Settings to enter the **OSD Settings** interface.



Figure 4.11 OSD Settings

2. Select the camera for configuration from the dropdown list of Camera, and edit the Camera Name
3. Check the corresponding checkbox to display the Name/Date/Week.
4. Set the Date/Time format and OSD Display Mode.
5. Tap **Copy** to copy the OSD settings to the other cameras.

Configuring Video Parameters

Steps:

1. Tap **Set** of the Video Parameters to enter the **Video Parameters** interface.



Figure 4.12 Video Parameters Settings

2. Select the camera for configuration from the dropdown list of Camera.
3. Set the Encoding Parameters, Stream Type, Resolution, Frame Rate, Bit Rate Type, Max. Bit Rate, and Image Quality.
4. Tap **Copy** to copy the video parameters to the other cameras.

Configuring Record Settings

Steps:

1. Tap **Set** of the Record Settings to enter the **Record Settings** interface.



Figure 4.13 Record Settings

● Editing Record Schedule

Steps:

1. On the **Record Settings** interface, select the camera for configuration from the Camera dropdown list.
2. Tap **Edit** to enter **Record Schedule** setting interface.



Figure 4.14 Record Schedule Settings

3. Check the checkbox of **Enable Schedule** item.
4. Select the day you want to set record schedule. You can also select it to All Week.
5. To schedule an all-day recording, tap the checkbox of the **All Day** item.
6. Select the recording type for the selected day to Continuous, Motion Detection, Alarm, Motion / Alarm or Motion & Alarm.
7. Configure the period for each day and select the recording type for the selected period.



Up to 8 periods can be configured for each day.

8. Tap **Save** to save the current settings and **Cancel** to return to the previous interface.
9. On the **Record Settings** interface, you can view the configured recording schedule.



Figure 4.15 Record Schedule

10. If you want to configure the other cameras with the same settings, select the camera from the Copy to dropdown list and tap **Copy**. You can also select **All** to copy the current settings to all cameras.
11. Tap **Apply** to save the current settings and **Cancel** to return to the previous interface.

● **Configuring Advanced Settings**

Steps:

1. On the **Record Settings** interface, select the camera for configuration from the Camera dropdown list.
2. Tap **Advanced** to enter the **Advanced Settings** interface where you can configure the pre-record, post-record, expired time, redundant record and record audio.



Figure 4.16 Advanced Settings

- **Pre-record:** The time you set to record before the scheduled time or event. For example, when an alarm triggered the recording at 10:00, if you set the pre-record time as 5 seconds, the camera records it at 9:59:55.

- **Post-record:** The time you set to record after the event or the scheduled time. For example, when an alarm triggered the recording ends at 11:00, if you set the post-record time as 5 seconds, it records till 11:00:05.
- **Expired Time:** The expired time is the longest time for a record file to be kept in the HDD, if the deadline is reached, the file will be deleted. You can set the expired time to 0, and then the file will not be deleted. The actual keeping time for the file should be determined by the capacity of the HDD.
- **Redundant Record:** Enabling redundant record or capture means you save the record and captured picture in the redundant HDD.
- **Record Audio:** Select Yes to record the sound, or No to record the image without sound.

Configuring Motion Detection

Purpose:

In the live view mode, once a motion detection event takes place, the device can analyze and handle it. Enabling motion detection function can trigger certain channels to start recording, or trigger full screen monitoring, audio warning, notify the surveillance center and so on. In this section, you can follow the steps to schedule a record which is triggered by the detected motion.

Steps:

1. On the **Camera Settings** interface, tap **Set** of the Motion Detection to enter the **Motion Detection Settings** interface.



Figure 4.17 Motion Detection Settings

2. Select the camera for configuring motion detection.
3. Check the checkbox of **Enable** item to enable motion detection.
4. Set the sensitivity level. Up to 6 levels and Off are selectable.
5. Tap the **Set** button beside Area Settings to set motion detection area.



Figure 4.18 Draw Area

6. Check the checkbox of **Start Drawing**, and then use the pen or touch to tap two points on the live view screen to draw area for motion detection.
7. To clear the motion detection area (s), tap **Clear All**.
8. Tap **OK** to save the settings and return to the **Motion Detection Settings** interface.
9. Tap the **Set** button beside Arming Schedule to configure the arming schedule of motion detection for the current camera. You can also copy the arming schedule to the other days.

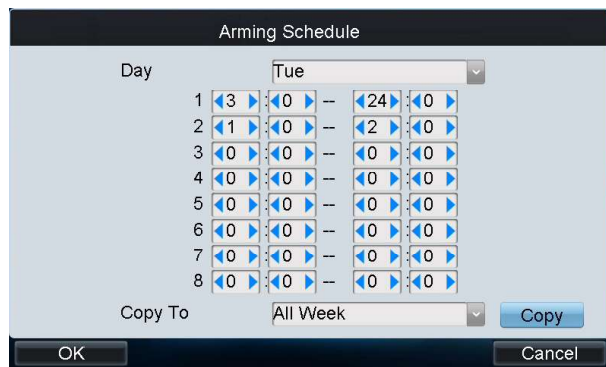

Figure 4.19 Set Arming Schedule

10. Tap **OK** to save the settings and return to the **Motion Detection Settings** interface.
11. Tap the **Set** button beside Linkage Action to configure the linkage method.
12. Tap **Linkage Action** to enter the **Linkage Action Settings** interface.



Figure 4.20 Set Linkage Action

13. If the Trigger Alarm Output is selected, you should tap the **Set** button to configure the triggered alarm output (s).



Figure 4.21 Trigger Alarm Output

14. Check the checkbox(s) to trigger alarm output(s). Tap **OK** to save the settings.
15. Tap **Triggered Camera** to enter the **Triggered Camera Settings** interface.

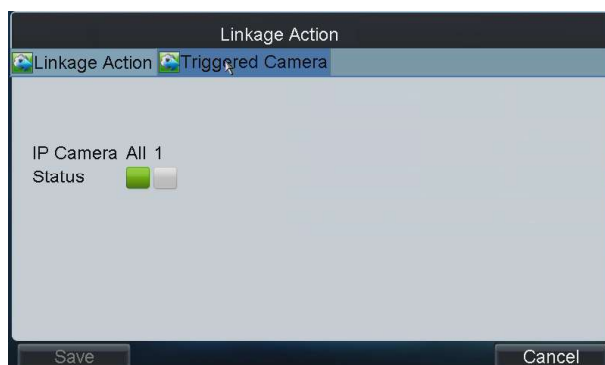

Figure 4.22 Triggered Camera Settings

16. Check the checkbox(s) to trigger the camera(s) you select. Tap **OK** to save the settings and **Cancel** to return to the previous interface.
17. Tap **Apply** to save the current settings and **Cancel** to return to the previous interface.

Configuring Video Loss Detection

Purpose:

Detect the video loss of a camera and take alarm response action(s).

Steps:

1. On the **Camera Settings** interface, tap **Set** beside the Video Loss to enter the **Video Loss** interface..

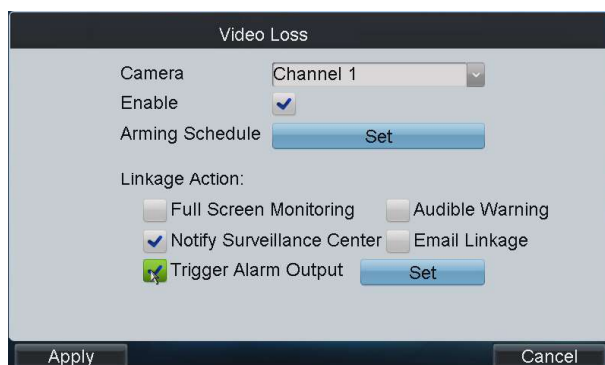

Figure 4.23 Set Video Loss Detection

2. Select the camera for configuring video loss detection.
3. Check the checkbox of **Enable** item to enable video loss detection.
4. Tap the **Set** button beside Arming Schedule to configure the arming schedule of video loss detection for the current camera. You can also copy the arming schedule to the other days.



Figure 4.24 Set Arming Schedule

5. Tap **OK** to save the settings and return to the **Video Loss** interface.
6. If the Trigger Alarm Output is selected, you should tap the **Set** button to configure the triggered alarm output (s).

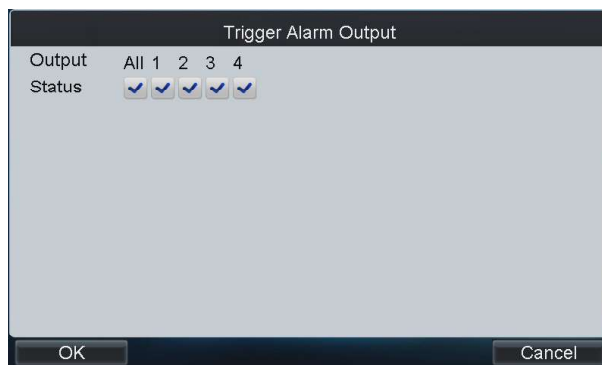

Figure 4.25 Trigger Alarm Output

7. Check the checkbox(s) to trigger alarm output(s). Tap **OK** to save the settings.
8. Tap **Apply** to save the current settings and **Cancel** to return to the previous interface.

Configuring Video Tampering Alarm

Purpose:

Trigger alarm when the lens is covered and take alarm response action(s).

Steps:

1. On the **Camera Settings** interface, tap **Set** beside Tampering Alarm to enter the **Tampering Alarm** settings interface.



Figure 4.26 Set Video Tampering Alarm

2. Select the camera for configuring video tampering detection.
3. Check the checkbox of **Enable** item to enable video tampering detection.
4. Set the Sensitivity level to High, Middle or Low.
5. Tap the **Set** button beside Area Settings to set video tampering detection area. Please refer to the settings of motion detection area for reference.
6. Tap the **Set** button beside Arming Schedule to configure the arming schedule of video tampering detection for the current camera. Please refer to the arming schedule settings of motion detection for reference.
7. Set the Linkage Action by selecting the methods listed. If the Trigger Alarm Output is selected, you should tap the **Set** button to configure the triggered alarm output(s). Please refer to the triggered alarm output settings of motion detection for reference.
8. Tap **Apply** to save the current settings and **Cancel** to return to the previous interface

Configuring Privacy Mask

Purpose:

You are allowed to configure the four-sided privacy mask zones that cannot be viewed by the operator.

Steps:

1. On the **Camera Settings** interface, tap **Set** beside Privacy Mask to enter the **Privacy Mask** settings interface.



Figure 4.27 Set Privacy Mask

2. Select the camera for configuring privacy mask.

3. Check the checkbox of **Enable** item to enable privacy mask.
4. Tap the **Set** button beside Area Settings to set privacy mask area. Please refer to the settings of motion detection area for reference.



Figure 4.28 Area Settings

5. Tap **Apply** to save the settings and **Cancel** to return to the previous interface.

Configuring IP Camera

Purpose:

If the current input device is Hybrid DVR, you can configure the IP camera and analog camera. If the current input device is Embedded NVR, you can configure the IP camera.

● **Adding IP Camera**

1. Tap **Set** beside IP Camera on the **Camera Settings** interface to enter the **Channel List** interface.
2. Tap the **IP Camera List** tag to enter the **IP Camera Management** interface.

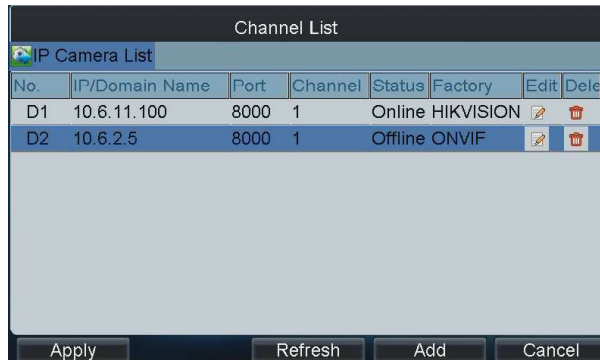

Figure 4.29 IP Camera List

3. Tap **Add** to enter the **IP Camera Parameters** interface.

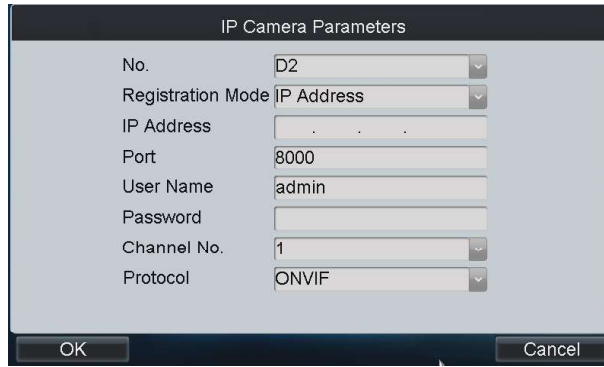

Figure 4.30 Set IP Camera Parameters

4. Configure the Camera No., Registration Mode (IP address/domain name), IP address/Domain name, Port, User Name, Password, Channel No. and Factory (protocol type) to add the IP camera.
5. Tap **OK** to save the settings.
6. On the **Channel List** interface, tap **Apply** to finish the adding of the IP camera.

● **Editing Status of Analog Camera**

For Hybrid DVR, you can view the status of the connected analog camera, as well as increase the number of IP camera by disabling the analog camera (s).

Steps:

1. Tap the **Analog List** tag to enter the **Analog Camera Management** interface. You can view the information of the connected analog camera.



Figure 4.31 Analog Camera List

2. Tap **Status** to enter the **Analog Camera Status** interface.

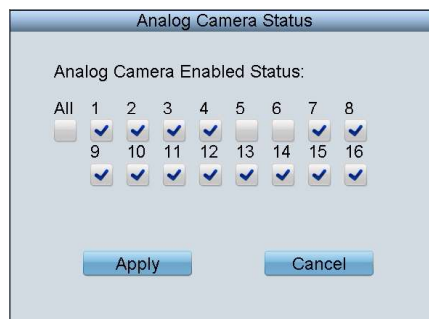

Figure 4.32 Analog Camera Status

3. You can deselect the camera (s) to disable the analog camera(s) connected.

4.3.4 Alarm Settings

Purpose:

You can configure the alarm input, alarm output and manual alarm.

Tap **Alarm** on the **Remote Settings** interface to enter the **Alarm Settings** interface.



Figure 4.33 Alarm Settings

Configuring Alarm Input

Steps:

1. Tap **Set** beside Alarm Input to enter the **Alarm Input Settings** interface.



Figure 4.34 Set Alarm Input

2. Select the Alarm Input for configuration.
3. Edit the Alarm Name.
4. Select the Alarm Type to Normally Open or Normally Close.
5. Set the handling action for the selected alarm input by checking the checkbox of Handling Alarm.
6. Tap the **Set** button beside the Arming Schedule to set the arming schedule of the alarm input. Please refer to the arming schedule settings of motion detection for reference.
7. Tap the **Set** button beside the Linkage Action to set the alarm response actions, as well as triggered camera and PTZ linkage.

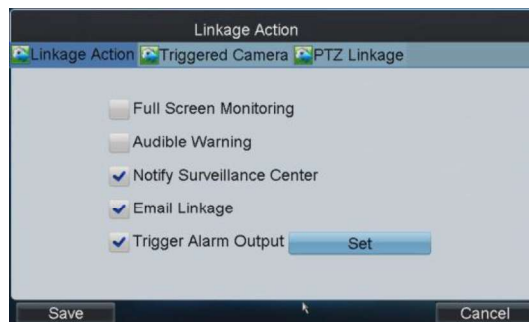

Figure 4.35 Set Linkage Action

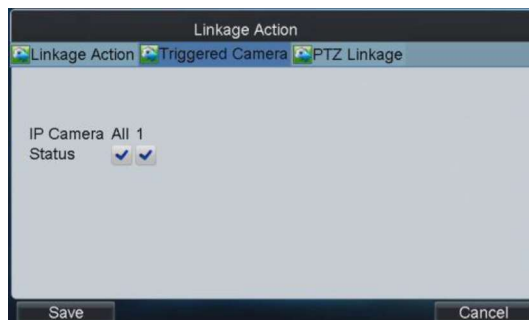

Figure 4.36 Set Triggered Camera

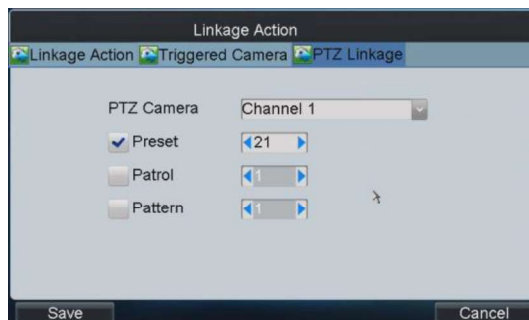

Figure 4.37 Set PTZ Linkage

8. After having configured the above setting and if you want to configure the other alarm inputs with the same settings, select the alarm input and tap **Copy**. You can also select **All** to copy the current settings to all alarm inputs.
9. Tap **Apply** to save the current settings and **Cancel** to return to the previous interface.

 **NOTE**

Please refer to the User Manual of the current DVR for detailed instructions.

Configuring Alarm Output

Steps:

1. Tap **Set** beside Alarm Output to enter the **Alarm Output Settings** interface.

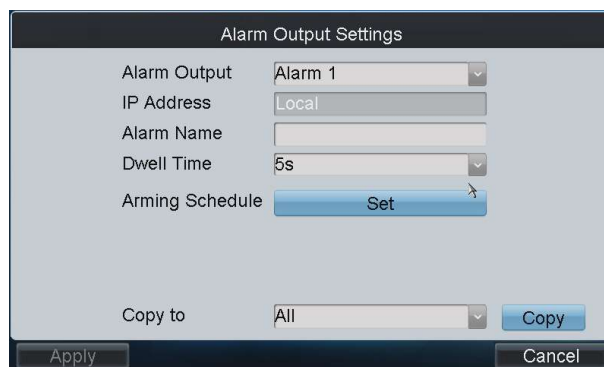

Figure 4.38 Set Alarm Output

2. Select the Alarm Output for configuration.
3. Edit the Alarm Name.
4. Set the Dwell Time (duration) for the alarm output.
5. Tap the **Set** button beside the Arming Schedule to set the arming schedule of the alarm output. Please refer to the arming schedule settings of motion detection for reference.
6. After having configured the above setting and if you want to configure the other alarm outputs with the same settings, select the alarm output and tap **Copy**. You can also select **All** to copy the current settings to all alarm outputs.
7. Tap **Apply** to save the current settings and **Cancel** to return to the previous interface.

Configuring Manual Alarm

Steps:

1. Tap **Set** beside Manual Alarm to enter the **Manual Alarm Settings** interface.



Figure 4.39 Set Manual Alarm

2. Select the alarm output (s) for manual triggering.
3. Tap **OK** to save the settings and return to the **Alarm Settings** interface.

4.3.5 Exceptions

Purpose:

You can configure the exception handling method (s) for each exception type.

Steps:

1. Tap **Exceptions** on the **Remote Settings** interface to enter the **Exception Settings** interface.

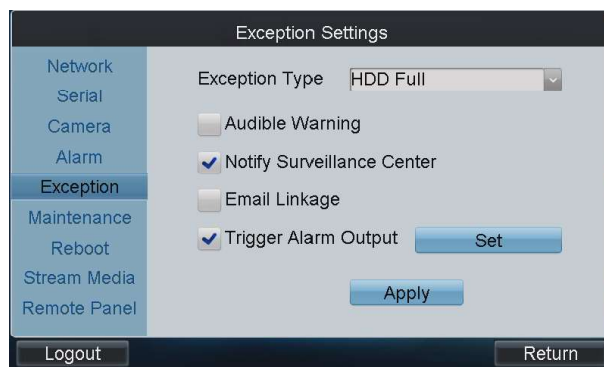

Figure 4.40 Set Exceptions

2. Select the Exception Type to configure with handling method (s). E.g.,
 - **HDD Full:** The HDD is full.
 - **HDD Error:** Writing HDD error, unformatted HDD, etc.
 - **Network Disconnected:** Disconnected network cable.
 - **IP Conflicted:** Duplicated IP address.
 - **Illegal Login:** Incorrect user ID or password.
3. Select the handling method (s) by checking the checkbox (s) for the selected exception type.
 - **Audible Warning:** Audible *beep* when an alarm is detected.
 - **Notify Surveillance Center:** Send an exception or alarm signal to remote alarm host when an event occurs. The alarm host refers to the PC installed with Remote Client.
 - **Email Linkage:** Send an email with alarm information to a user or users when an alarm is detected.
 - **Trigger Alarm Output:** Trigger an alarm output when an alarm is triggered. You can tap the **Set** button to set the alarm output (s) to trigger.
4. If the Trigger Alarm Output is selected, you should tap the **Set** button to configure the triggered alarm output (s). Refer to the triggered alarm output settings of motion detection for reference.
5. Tap **Apply** to save the current settings.

4.3.6 Maintenance

Steps:

1. Tap **Maintenance** on the **Remote Settings** interface to enter the **Device Maintenance** interface.



Figure 4.41 Device Maintenance

2. Tap the **Set** button to set the corresponding parameters.
 - **HDD Management:** Set and initialize HDD, and set HDD in group management.
 - **User Management:** Add/edit/delete user account, and assign operating permissions for each user.
 - **Device Information:** View the version and basic information of the input device.
 - **Device Upgrade:** Remotely upgrade the device by USB file.
 - **Import/Export:** Import/export configuration files.
 - **Restore Default:** Restore factory default settings.
 - **Remote Panel:** Use the remote front panel of the device to realize operation.

4.3.7 Stream Media Settings

Purpose:

The stream media sever only takes effect when the video needs to be decoded and displayed on the video wall. The decoder connects with the stream media server to get the video stream.

Steps:

1. Tap **Stream Media** on the **Remote Settings** interface to enter the **Stream Media Settings** interface.

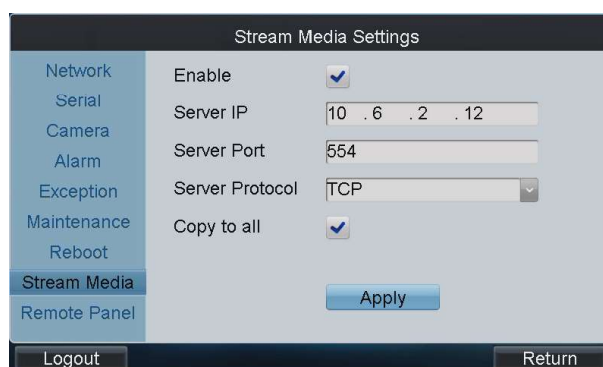

Figure 4.42 Set Stream Media

2. Enable the Stream Media by checking the checkbox.
3. Input the IP address and port of the server.

 **NOTE**

The Server IP refers to the IP address of the PC on which the stream media software is running.

4. You can check the checkbox of **Copy to all** to copy the current stream media settings to all the input devices under the current login user. If you uncheck it, the stream media settings are applicable to the current input device only.
5. Tap **Apply** to save the settings.

4.3.8 Remote Panel Settings

Purpose:

The keyboard can control the front panel of the added DVR/NVR.

Steps:

1. Tap **Remote Panel** on the **Remote Settings** interface to enter the **Remote Panel** interface.

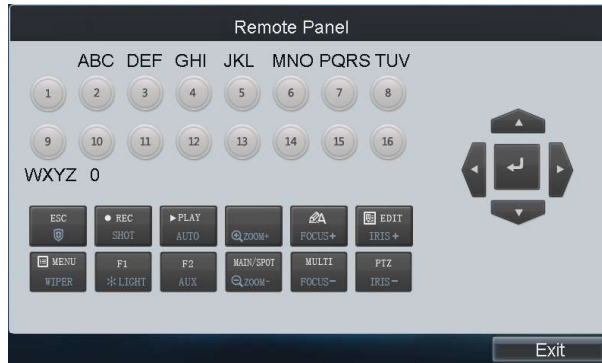

Figure 4.43 Remote Panel

2. Tap the buttons on the remote panel to control the front panel of the DVR/NVR.
3. Tap **Exit** to return to the previous interface.

4.4 Decoding Device Settings

Purpose:

You can configure the settings for network, RS-232/RS-485 serial port, output, video wall, decoding status, etc. of the added decoders.

Tap the  of a decoder on the **Device List** interface and enter its **Remote Settings** interface.



Figure 4.44 Decoder List

4.4.1 Network Settings

Steps:

1. Tap **Network** on the **Remote Settings** interface to enter the **Network Settings** interface.

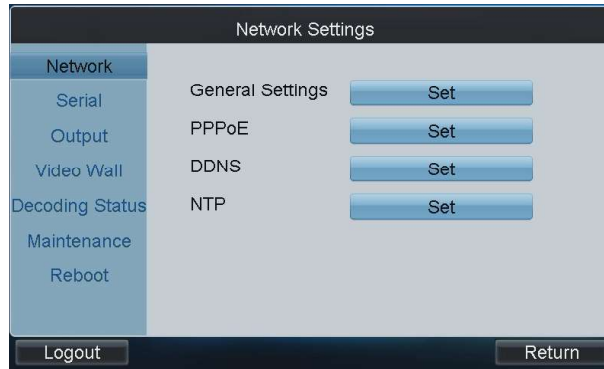

Figure 4.45 Network Settings

2. You can configure the General Settings, PPPoE, DDNS and NTP parameters of the decoder. Please refer to [Chapter 4.3.1 Network Settings](#) for reference.

4.4.2 Serial Port Settings

Steps:

1. Tap **Serial** on the **Remote Settings** interface to enter the **Serial Port Settings** interface.



Figure 4.46 Serial Port Settings

2. You can set the RS232 and RS485 port parameters.



Figure 4.47 RS-232 Port Settings



Figure 4.48 RS-485 Port Settings

4.4.3 Output Settings

Purpose:

You can configure parameters for the display of decoded output video on monitor.

Steps:

1. Tap **Output** on the **Remote Settings** interface to enter the **Output Settings** interface.

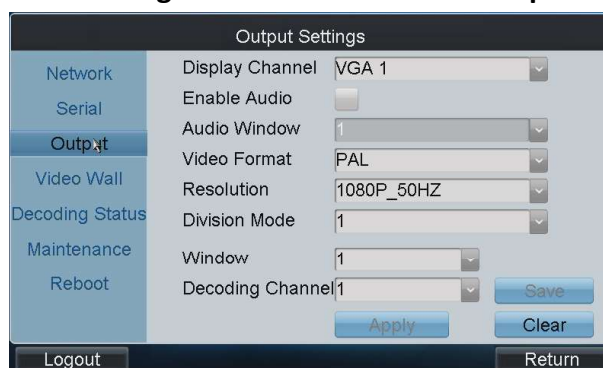

Figure 4.49 Output Settings

2. Select the display channel.
3. Enable audio and configure it for a window if required.
4. Set the video format and resolution of the decoded video output.
5. Select the window division mode.

 **NOTE**

The window division modes vary with the different modes of the decoders.

6. Link decoding channel to the window.
 - (1) Select a window and its relevant decoding channel.
 - (2) Tap **Save** to save the current window settings.
 - (3) Repeat the same steps to configure the other windows for their related channels.
7. After having configured the above settings, tap **Apply** to finish the settings or **Clear** to cancel the settings.

4.4.4 Video Wall Settings

Purpose:

Decoding devices such as DS-6400HDI-T, DS-6400HDI-S, DS-6500HDI-T or DS-6900UDI-T can be added. The video wall display is supported. You can decode the video signal and display it on the video wall.

Steps:

1. Tap **Video Wall** on the **Remote Settings** interface to enter the **Video Wall Settings** interface.



Figure 4.50 Video Wall Settings

2. Select the Video Wall No. to configure and enable the video wall display by checking the **Enable** checkbox.
3. Select the window division mode.



The window division modes vary with the different modes of the decoders.

4. Select the Decoding Channel and the output Resolution.
5. Link the output channel to the screen.
 - (1) Select the Screen No. of the selected video wall and the Output Channel of the decoder.
 - (2) Tap **Save** to save the current settings.
 - (3) Repeat the same steps to configure the other screens for their related output channels.
6. After having configured the above settings, tap **Apply** to finish the settings.

4.4.5 Viewing Decoding Status

Steps:

1. Tap **Decoding Status** on the **Remote Settings** interface to enter the **Decoding Status** interface.



Figure 4.51 View Decoding Status

2. You can view the working status of each Decoding Channel, including the Decoding Status,

Stream Type, Package Mode, Video/Audio Frame Rate, etc.

4.4.6 Maintenance

Steps:

1. Tap **Maintenance** on the **Remote Settings** interface to enter the **Device Maintenance** interface.



Figure 4.52 Device Maintenance

2. Tap **Set** to set the parameters below.
 - **User Management:** Add/edit/delete user account, and assign operating permissions for each user.
 - **Device Information:** View the version and basic information of the decoder device.
 - **Device Upgrade:** Remotely upgrade the device by USB file.
 - **Import/Export:** Import/export configuration files.
 - **Restore Default:** Restore factory default settings.

4.5 Input Settings

Purpose:

You can view all the input channels which can be controlled by the current login user, realize local live view and live-view by channel-zero, edit the input channels and set input group.

Tap **Input** on the *operator* main interface to enter the **Input Settings-Input List** interface.

Search by IP or domain is supported. Input the IP address or domain of the device in the text field and tap the **Search** button.



NOTE

The name shown in the Name column is obtained from the corresponding device.

No.	Name	Device	Type	IP Address	Port	Edit	Live
1			IP Dome	10.10.38.169	8000		
2	IPdome	12	IP Dome	10.10.0.55	8000		
3	Camera 1	10.6.11.1	NVR	10.6.11.15	8000		
4	Camera 2	10.6.11.1	NVR	10.6.11.15	8000		
5	Camera 3	10.6.11.1	NVR	10.6.11.15	8000		
6	Camera 4	10.6.11.1	NVR	10.6.11.15	8000		
7	Camera 5	10.6.11.1	NVR	10.6.11.15	8000		
8	VGA1	155	DEC	10.6.11.155	8000		

Figure 4.53 Input List

4.5.1 Starting Local Live View

Steps:

1. Select a channel from the input list and tap the  icon to start the local live view.



Figure 4.54 Local Live View

2. You can press the **NEXT** or **PREV** button to view the video of the next or previous channel.
3. Press **ESC** button to return to the input list.

 **NOTE**

Local live view is not supported by local source input.

4.5.2 Live View by Channel-Zero

Steps:

1. Tap the **Channel-Zero** button on the **Input Settings-Input List** interface to enter the **Channel-Zero** settings interface:

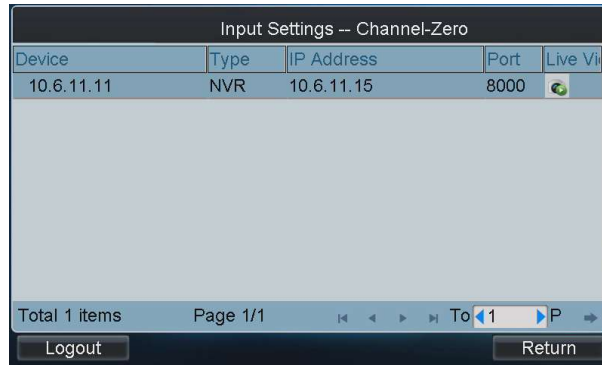

Figure 4.55 Channel-Zero Settings

2. Select an encoding device from the list and tap the icon to enter the local live view by the channel-zero.

NOTE

The channel-zero must be supported by the connected encoding device and has been enabled.

4.5.3 Editing a Camera

Steps:

1. Select a camera from the **Input Settings-Input List** interface, and tap to enter the **Edit Camera** interface.



Figure 4.56 Edit Camera

2. Edit the Camera Name, Camera No., Protocol, and Stream Type.

NOTE

The Camera No. should be set uniquely from 1 to 999999.

4.5.4 Setting Input Group

Steps:

1. Tap **Input Group** to enter the **Input Settings-Input Group** interface.

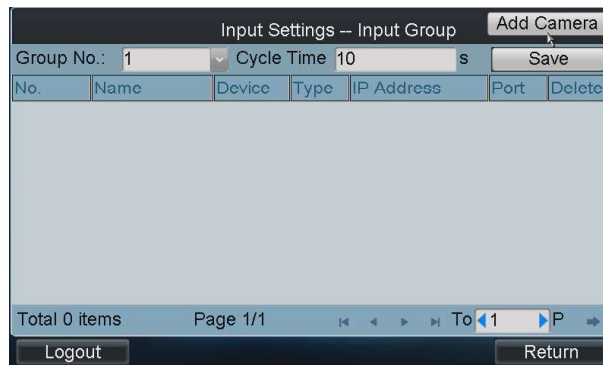

Figure 4.57 Input Group Settings

2. Tap to select the Group No. from the drop-down list, set the Cycle Time for the group and tap the **Save** button.

NOTE

- Up to 16 input groups can be added.
- The range of the cycle time is from 10s to 1000s.

3. Tap the **Add Camera** button to enter the **Add Camera** interface:



Figure 4.58 Add Camera

4. Select the cameras from the list to be added to the group, and then tap **Add** to add them.
5. Tap **OK** to return to the **Input Group** interface, where you can view the successfully added cameras for the current group.
6. (Optional) You can tap to delete the added camera.

4.6 Output Settings

Purpose:

You can view all the output channels added to the current login user, play back, edit the output channels, set output group and set video wall/scene.

Tap **Output** on the *operator* main interface to enter the **Output Settings** interface.

Search by IP or domain is supported. Input the IP address or domain of the device in the text field and tap the **Search** button.

No.	Type	Device	IP Address	Port	Edit	Playb
1	VGA1	Embedded multi	172.6.22.190	8000		
2	VGA2	Embedded multi	172.6.22.190	8000		
3	VGA3	Embedded multi	172.6.22.190	8000		
4	VGA4	Embedded multi	172.6.22.190	8000		
5	VGA5	Embedded multi	172.6.22.190	8000		
6	VGA6	Embedded multi	172.6.22.190	8000		
7	VGA7	Embedded multi	172.6.22.190	8000		
8	VGA8	Embedded multi	172.6.22.190	8000		

Figure 4.59 Output List

4.6.1 Playback on Monitor

Purpose:

Playback by file and playback by time are supported.



NOTE

Before operating the playback, you must configure the output settings first. Please refer to *Chapter 4.4.3 Output Settings*.

Playback by File

Steps:

1. Select an output channel from the output list and tap the icon to enter the **Playback** interface.
2. Tap the **By File** tab to enter the **Playback by File** interface.

Figure 4.60 Playback by File

3. Input the display window.



NOTE

Please refer to the window division mode in the *Chapter 4.4.3 Output Settings* before inputting the display window here.

4. Input the Camera No. for playback.
If the encoding device is ATM DVR, you can check the checkbox of By Card No. and input the Card No.
5. Select the Record Type and File Type.
6. Set the start time and end time of the video files for playback.
7. Tap **Search** to search the matched video files.
8. The searching results can be viewed on the **Playback File List** interface.

File Name	Start Time	End Time	Size	Type
ch01_08(2013-01-25 11:28:59	2013-01-25 11:28:59	2013-01-25 12:33:56	725.1MB	Unlock
ch01_08(2013-01-25 12:33:56	2013-01-25 12:33:56	2013-01-25 14:05:44	1016.4MB	Unlock
ch01_08(2013-01-25 14:05:44	2013-01-25 14:05:44	2013-01-25 14:52:19	521.9MB	Unlock
ch01_08(2013-01-25 14:54:11	2013-01-25 14:54:11	2013-01-25 14:57:35	26.9MB	Locked
ch01_08(2013-01-25 15:01:14	2013-01-25 15:01:14	2013-01-25 15:43:12	467.1MB	Unlock
ch01_08(2013-01-25 15:43:12	2013-01-25 15:43:12	2013-01-25 17:13:33	1016.4MB	Unlock
ch01_08(2013-01-25 17:13:33	2013-01-25 17:13:33	2013-01-25 18:42:56	1016.2MB	Unlock
ch01_08(2013-01-25 18:42:56	2013-01-25 18:42:56	2013-01-25 19:22:55	457.7MB	Unlock

Total 8 items Page 1/1

Figure 4.61 Search Result

9. Select the file for playback from the list and tap **Playback** to play back the video file.

NOTE

The Playback Control buttons on the left side of the control panel are supported during the playback.

Playback by Time

Steps:

1. Tap the **By Time** tab to enter the **Playback by Time** settings interface.

Figure 4.62 Playback by Time

2. Input the display window.

NOTE

Please refer to the window division mode in the *Chapter 4.4.3 Output Settings* before inputting the display window here.

3. Input the Camera No. for playback.
4. Set the Start Time and End Time of the video files for playback.
5. Tap **Playback** to start playback.

 **NOTE**

The Playback Control buttons on the left side of the control panel are supported during the playback.

4.6.2 Playback on Window

 **NOTE**

Only 69UD decoder and 65UD decoder support Playback on window.
Click **Playback** from the **Output Settings—Output List** interface

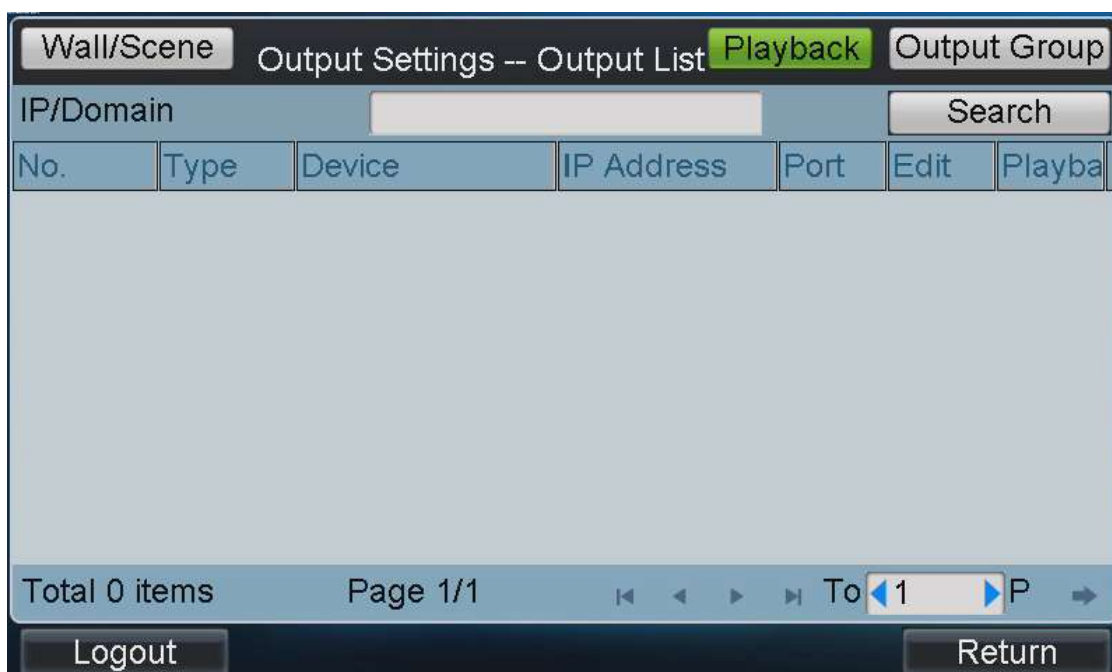

Figure 4.63 Playback

Playback by File

Steps:

1. Tap the **By File** tab to enter the **Playback by File** interface.



Figure 4.64 Playback by File

- Input the Main Window and the Sub Window. The *Num* in Main Window is the sum of the segment No. and the window No. The *Num* in Sub Window is the number of Sub-window when the output channel divided.

NOTE

The window No. should be less than the number of multi-division display mode set in *Chapter 4.4.3 Output Settings*. The Sub-Window No. should be less than the number of multi-division display mode for the output in 4200.

- Input the Camera No. for playback.
If the encoding device is ATM DVR, you can check the checkbox of By Card No. and input the Card No.
- Select the Record Type and File Type.
- Set the start time and end time of the video files for playback.
- Tap **Search** to search the matched video files.
- The searching results can be viewed on the **Playback File List** interface.

File Name	Start Time	End Time	Size	Type
ch01_08(2013-01-25 11:28:59	2013-01-25 11:28:59	2013-01-25 12:33:56	725.1MB	Unlock
ch01_08(2013-01-25 12:33:56	2013-01-25 12:33:56	2013-01-25 14:05:44	1016.4ME	Unlock
ch01_08(2013-01-25 14:05:44	2013-01-25 14:05:44	2013-01-25 14:52:19	521.9MB	Unlock
ch01_08(2013-01-25 14:54:11	2013-01-25 14:54:11	2013-01-25 14:57:35	26.9MB	Locked
ch01_08(2013-01-25 15:01:14	2013-01-25 15:01:14	2013-01-25 15:43:12	467.1MB	Unlock
ch01_08(2013-01-25 15:43:12	2013-01-25 15:43:12	2013-01-25 17:13:33	1016.4ME	Unlock
ch01_08(2013-01-25 17:13:33	2013-01-25 17:13:33	2013-01-25 18:42:56	1016.2ME	Unlock
ch01_08(2013-01-25 18:42:56	2013-01-25 18:42:56	2013-01-25 19:22:55	457.7MB	Unlock

Total 8 items Page 1/1 To 1 P

Figure 4.65 Search Result

8. Select the file for playback from the list and tap **Playback** to play back the video file.

 **NOTE**

The Playback Control buttons on the left side of the control panel are supported during the playback.

Playback by Time

Steps:

1. Tap the **By Time** tab to enter the **Playback by Time** settings interface.



Figure 4.66 Playback by Time

2. Input the Main Window and the Sub Window. The *Num* in Main Window is the sum of the segment No. and the window No. The *Num* in Sub Window is the number of Sub-window when the output channel divided.

 **NOTE**

The window No. should be less than the number of multi-division display mode set in *Chapter 4.4.3 Output Settings*. The Sub-Window No. should be less than the number of multi-division display mode for the output in 4200.

3. Input the Camera No. for playback.
4. Set the Start Time and End Time of the video files for playback.
5. Tap **Playback** to start playback.

 **NOTE**

The Playback Control buttons on the left side of the control panel are supported during the playback.

4.6.3 Editing an Output Channel

Steps:

1. Select an output channel from the **Output Settings-Output List** interface, and tap  to enter the **Edit Output** interface.

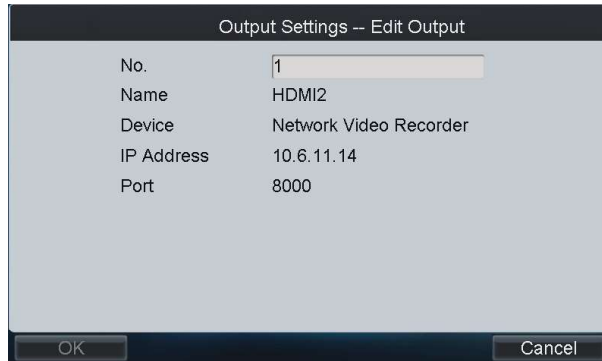

Figure 4.67 Edit Output

2. Edit the output No..



The Output No. should be set uniquely from 1 to 999999.

4.6.4 Setting Output Group

Steps:

1. Tap **Output Group** to enter the **Output Settings-Output Group** interface.
2. Tap  to select the Group No. from the drop-down list.

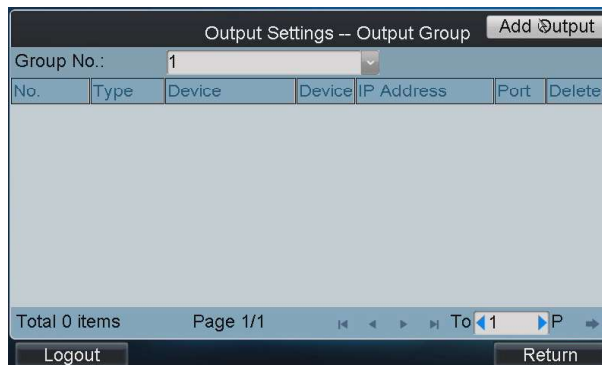

Figure 4.68 Set Output Group

3. Tap the **Add Output** button to enter the **Add Output** interface:

No.	Type	Device	Device	IP Address	Port
25	VGA5	DECODER	DEC	172.10.19.251	8000
26	VGA6	DECODER	DEC	172.10.19.251	8000
27	VGA7	DECODER	DEC	172.10.19.251	8000
28	VGA8	DECODER	DEC	172.10.19.251	8000
29	BNC1	DECODER	DEC	172.10.19.251	8000
30	BNC2	DECODER	DEC	172.10.19.251	8000
31	BNC3	DECODER	DEC	172.10.19.251	8000
32	BNC4	DECODER	DEC	172.10.19.251	8000

Total 40 items Page 4/5 To 4 P

Add OK

Figure 4.69 Add Output

4. Select the outputs from the list to be added to the group, and then tap **Add** to add them.
5. Tap **OK** to return to the **Output Group** interface, where you can view the successfully added output channels for the current group.
6. (Optional) You can tap  to delete the added output channel.

4.6.5 Setting Video Wall / Scene

Steps:

1. Tap the **Wall/Scene** button on the **Output List** interface to enter the **Video Wall/Scene List** interface.

No.	Name	Device	IP Address	Port
1	Screen 1	Embedded m	172.6.22.190	8000
2	Screen 2	Embedded m	172.6.22.190	8000
3	Screen 3	Embedded m	172.6.22.190	8000
4	Screen 4	Embedded m	172.6.22.190	8000

Total 4 items Page 1/1 To 1 P

Logout Return

Figure 4.70 Video Wall/Scene List

2. Tap  to enter the **Edit** interface.
3. Edit the No. for the video wall / scene on your demand.

Video Wall/Scene -- Edit

No.

Name Video Wall1

Device Embedded multiDecoder

IP Address 172.6.22.190

Port 8000

OK Cancel

Figure 4.71 Edit Video Wall/Scene

4. Tap **OK** button to save the setting.

4.7 Macro Settings

Purpose:

The macro command can be used for operating a series of continuous actions in sequence. You can press the “*Num + MAC*” keys to call the programmed macro command.

Tap **Macro** on the main interface to enter the **Macro Settings** interface.

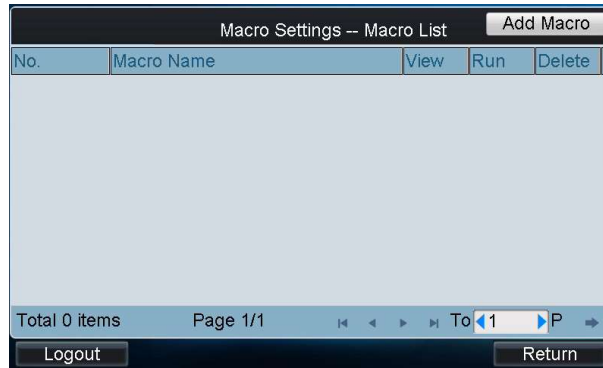

Figure 4.72 Macro Settings

4.7.1 Adding Macro

Steps:

1. Tap **Add Macro** to enter the **Macro Setting-Add Macro** interface.

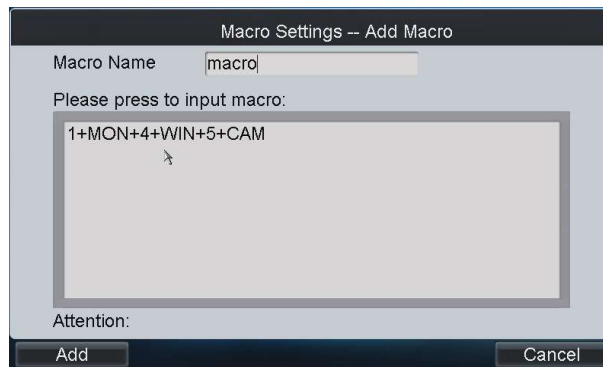

Figure 4.73 Add Macro

2. Edit the Macro Name, and press the command keys on the keyboard to enter the text box below.
3. Tap **Add** to add the current macro command.

NOTE

- Up to 128 macro commands can be added.
- Max. 8 numerals can be included in a macro command.
- The local decoding and live view operation is not supported currently.

4.7.2 Viewing Macro

Steps:

1. After adding macro, return to the **Macro List** interface and you can view the added macro command.

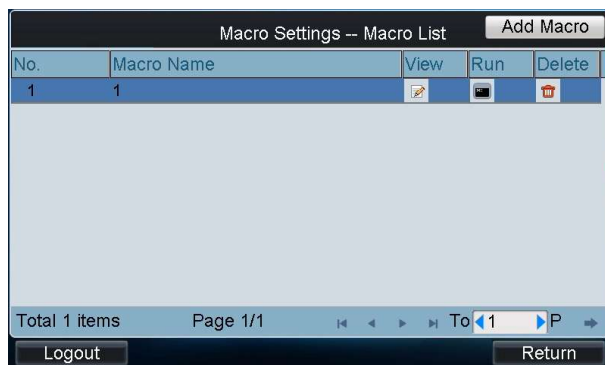

Figure 4.74 Macro List

2. Tap to view the macro command.

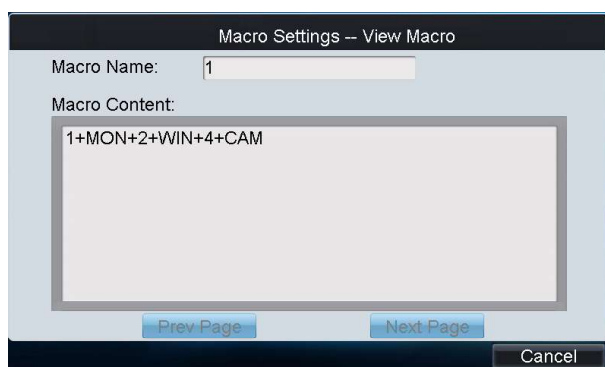

Figure 4.75 View Macro

3. You can tap **Prev Page** or **Next Page** to view the previous or next macro command.

4.7.3 Running Macro

Select a command from the list and tap to run the command, or directly tap **Num + MAC** keys on the interface to call the macro command.

4.7.4 Deleting Macro

You can tap to delete the added macro command.

4.8 Playback

Purpose:

The video files stored in the encoding device can be played back in the local keyboard. Three

Playback modes are available: playback by USB file, playback by time and playback by file. Tap **Playback** on the *operator* main interface to enter the **Local Playback** interface.

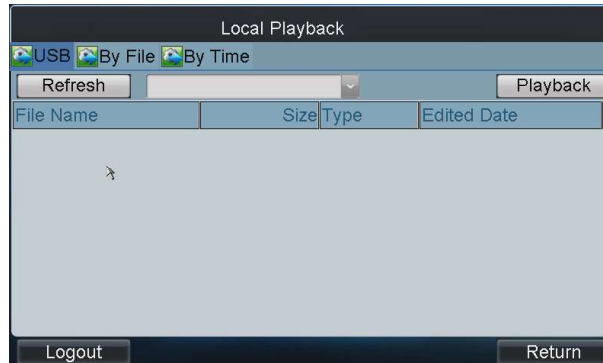

Figure 4.76 Local Playback

4.8.1 Playback by USB File

Steps:

1. Connect your USB disk to the keyboard.
2. Tap the **USB File** tab on the **Local Playback** interface to enter the **Playback by USB File** interface.

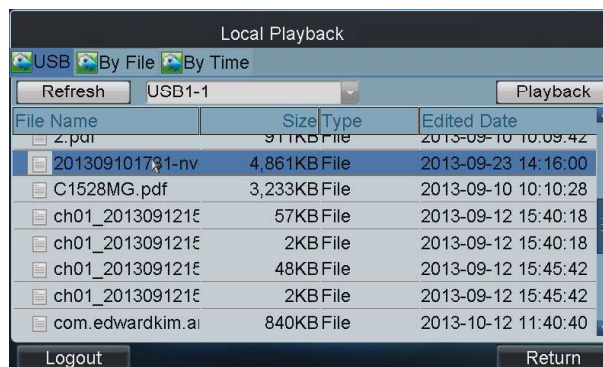

Figure 4.77 Playback by USB File

3. Select the video file from the USB disk for playback.
4. Tap **Playback** to play the selected video file.



Figure 4.78 Playback Interface

4.8.2 Playback by File

Steps:

1. Tap the **By File** tab on the Local **Playback** interface to enter the Playback by File interface.



Figure 4.79 Playback by File

2. Input the Camera No. for playback.
3. Select the Record Type and File Type.
If the encoding device is ATM DVR, you can input the Card No.
4. Set the Start Time and End Time of the video files for playback.
5. Tap **Search** to search the matched video files. The searching results can be viewed on the **Playback File List** interface.

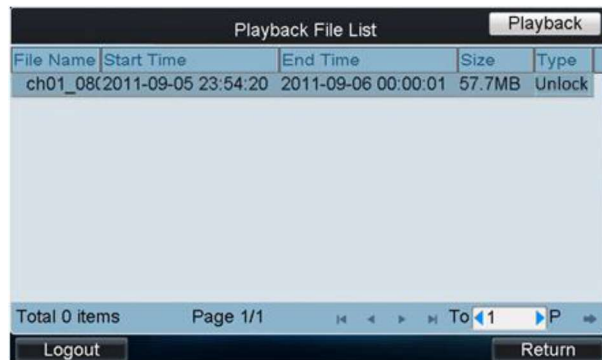

Figure 4.80 Search Result

6. Select the file for playback from the list and tap **Playback** to play back the video file.

4.8.3 Playback by Time

Steps:

1. Tap the **By Time** tab on the Local **Playback** interface to enter the **Playback by Time** interface.

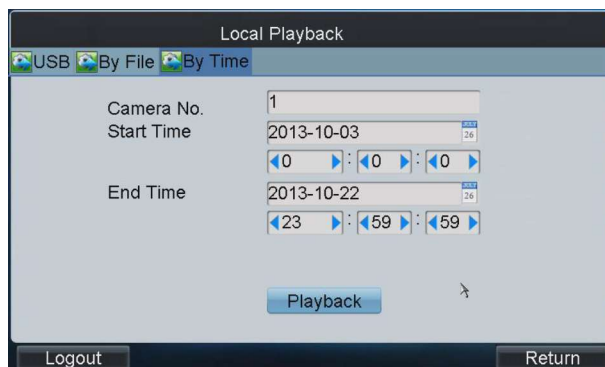

Figure 4.81 Playback by Time

2. Input the Camera No. for playback.
3. Set the Start Time and End Time of the video files for playback.
4. Tap **Playback** to play back the recording file.

4.9 Advanced Settings

Steps:

1. Tap **Advanced** on the *operator* main interface to enter the **Advanced Settings** interface.
2. You can configure the password, AUX key, live view performance and PTZ speed control settings.

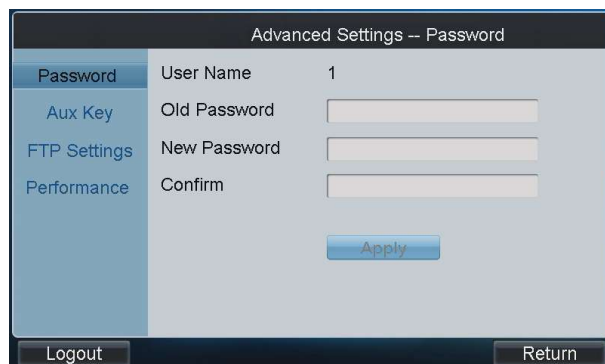

Figure 4.82 Advanced Settings

4.10 Password Settings

Steps:

1. Tap **Password** on the **Advanced Settings** interface to enter the **Password Settings** interface. It is allowed to edit the password for the current login user.
2. Enter the Current Password and New Password, and then tap **Apply** to finish the password modification.

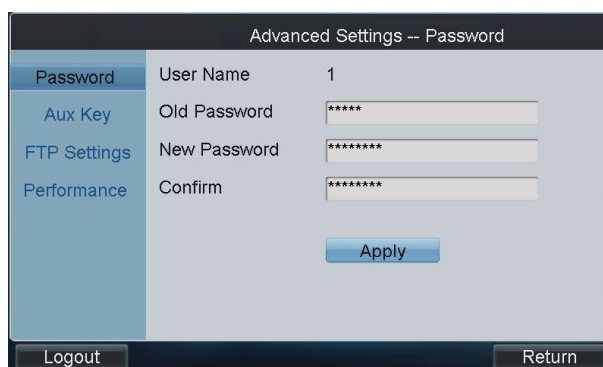

Figure 4.83 Modify Password

4.10.1 Auxiliary Key Settings

Steps:

1. Tap **Aux Key** on the Advanced Settings interface to enter the **Aux Key Settings** interface. The **Aux Key 1** and **Aux Key 2** correspond to the AUX1 and AUX2 keys on the keyboard respectively.
2. Tap to select the Aux function to be **Two-way Audio**, **Picture Capture** or **Video Wall/Scene Switch** control.
3. Tap **Apply** to save the settings.

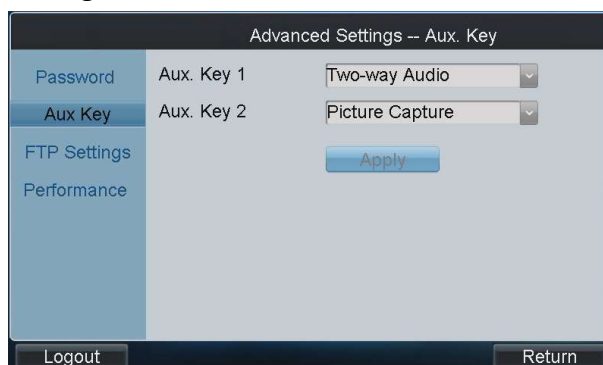

Figure 4.84 Set Aux Key

4.10.2 Live View & PTZ Speed Settings

Steps:

1. Tap **Performance** on the Advanced Settings interface to enter the Live View and PTZ Speed Performance interface.
2. Select the network performance of local live view on keyboard. Five levels are selectable.
3. Select the PTZ movement speed of the connected PTZ camera by using the joystick. Four levels are selectable.

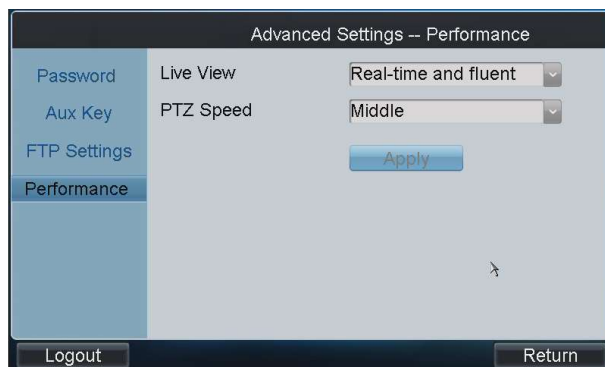

Figure 4.85 Performance Settings

4.11 Logout

Steps:

1. Tap **Logout** on the *operator* main interface, and the message box “Logout now?” will pop up.
2. Tap **Yes** to confirm the logout, or **No** to cancel the operation.
3. After logout of current login user, the system will return to the User Login interface.



Figure 4.86 User Login

4.12 Reboot

Steps:

1. Tap **Reboot** on the *operator* main interface, and the message box “Reboot now?” will pop up.
2. Tap **Yes** to confirm the reboot, or **No** to cancel the operation.

4.13 Shutdown

Steps:

1. Tap **Shutdown** on the main interface, and the message box “Shut down now?” will pop up.
2. Tap **Yes** to confirm the shutdown, or **No** to cancel the operation.

Chapter 5 Keyboard Operation

5.1 Shortcut Operation

The operating user must log in to the keyboard to realize all shortcut operations (except LOCK).

Shortcut Operation: Press the **Num** keys on the keyboard to enter the shortcuts operation interface.



NOTE

- When user enters the shortcuts operation interface by inputting the *Num* key, press *ESC* to cancel the input numeral from the screen and start the shortcut operation.
- When user enters the shortcuts operation interface by inputting the *SET* key, user should press it again before starting the shortcut operation.

In the shortcut operation interface, the left part has displayed the current output channel, and user can select different window-division display modes, set input channel for each window, or configure other shortcut operations. And the right part of the interface is used for displaying the current key input and some shortcut operations.



Figure 5.1 Shortcut

5.2 Local Live View

Purpose:

The local live view refers to display the video signal from the input channel through the network keyboard. Currently, only the 1-window display mode for 1 decoding channel is supported. In the live view mode, user can operate other shortcut functions.

Steps:

1. Press the *0+MON* keys to enter local live view.
2. Press the *Num + CAM* keys to select the camera for displaying on the screen.



NOTE

In the local operation status, it is unallowable to operate the window (WIN), camera group (CAM-G), multi-division display (MULT) and camera tour (TOUR) functions.

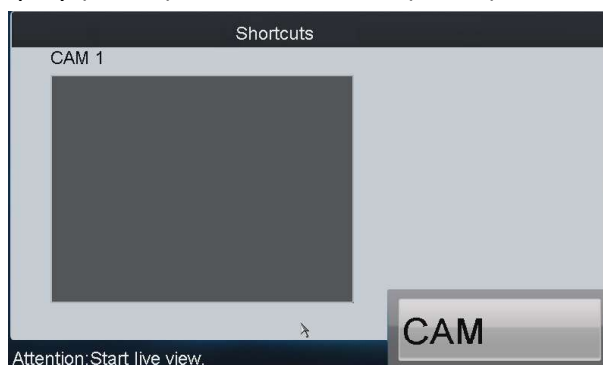

Figure 5.2 Local Live View

3. Press the **ESC** key on the keyboard to enter full-screen live view mode.



Figure 5.3 Full-Screen Live View

NOTE

- Up to 1080P resolution is supported for local live view.
- User can press the *O*+CAM keys to stop the live view of the current camera.

5.3 Displaying Decoded Video to Output Channel

5.3.1 Setting Multi-Division Display

Purpose:

You can select different multi-division display modes for the selected output channel. Currently, 1/2/4/6/8/9/12/16/25/32/36/64-division display modes are configurable. The configurable multi-division display modes depend on the decoders or Multi-function Video Center (MVC).

Steps:

1. Press the *Num* + *MON* keys to select the monitor.
2. Press the *Num* + *MULT* keys to select the multi-division display mode for the output channel.

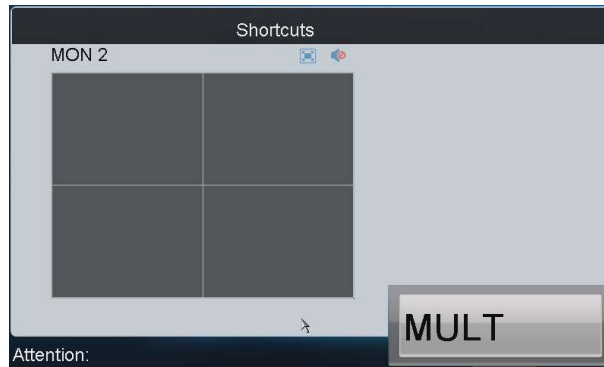

Figure 5.4 Set Multi-Division Display Mode

 **NOTE**

- In the local live view mode when you input $0+MON$ keys, the multi-division display mode is not supported.
- Corresponding error message will appear on the screen when user performs wrong operation. E.g., when the multi-division number entered is not supported by the current output channel, the message "Window mode error." will appear.

5.3.2 Displaying Video to Output Channel

Purpose:

The selected input signal can be output and displayed by the output channel. Currently, the supported decoding resolution includes: QCIF, CIF, 2CIF, DCIF, 4CIF, 720p, 1080p, VGA, UXGA, etc. The output interface can be selected to be BNC/VGA/HDMI/DVI.

Steps:

1. Press the *Num* + aux1/aux2 to select the Wall.

 **NOTE**

Only B20 V1.6 and B21 V1.4 support multi Wall. If other device added to list. There is no need to perform this step.

2. Press the *Num* + *MON* keys to select the output channel.
3. Press the *Num* + *WIN* keys to select the display window of the output channel.
You can also directly touch the screen to select the display window.
4. Press the *Num* + *CAM* keys to select the input camera.

Example:





You can press the " $1+MON, 4+WIN, 2+CAM$ " keys to decode the video signal from camera 2 and display it on window 4 of output channel 1.



Figure 5.5 Display Video on Monitor

Refer to Table 5.1 for the description of the icons on the shortcut interface.

Table 5.1 Description of Icons

Icon	Description
	Switch to full screen output of the selected window.
	Restore from the full screen output of the selected window.
	Audio-off
	Audio-on

 **NOTE**

- For the B20 MVC, video wall controller, and decoder (such as DS-6400HDI-T, and DS-6400HDI-S) added to the device list, the *Num* in Step 1 is the sum of the segment No. and the window No.. Step 2 is omitted. For example, you can press the “1001+MON, 3+CAM” keys to decode the video signal from camera 3 and display it on window 1 of the output channel of the MVC, video wall controller or decoder.
- For the decoder such as DS-6400HDI-T and DS-6400HDI-S, the output channels will not be displayed on the output list. For example, the segment No. of 64HD-T is 1000, and the window No. is 1, then the *Num* in Step 1 should be 1001. When window floating is enabled, press 1001 + MON keys to select window 1 of the output channel of the decoder, and then press *Num* + CAM to decode the video signal from the selected camera and display it on window 1. When window floating is disabled, the output channels of the decoder will be displayed on the output list. Follow the steps from 1 to 3 to display video on the output channel.
- When you press the 0+CAM keys, it will stop the dynamic decoding of the current window. If no display window is selected, the decoding of the 1st window will be stopped by default.
- In the local live view mode, when you input 0+MON keys, only the single-window display mode is supported.
- Corresponding error message will appear on the screen when you perform wrong operation.

5.3.3 Displaying Video of Camera Group to Output Channel

Purpose:

The video signal from the selected camera group can be output to and displayed by the output channel.

1. When the numbers of cameras are equal to or less than the numbers of display windows of the output channel, e.g., to display video of 8 cameras to 9 windows, then the video of each camera will be displayed on its corresponding window respectively, e.g., camera 1 on window 1, camera 8 on window 8, etc..
2. When the numbers of cameras are more than the numbers of display windows of the output channel, the video of the cameras will be displayed in cycle mode. E.g., to display video of 34 cameras to 16 windows, then the video of camera 1 to 16 will be displayed on window 1 to 16, and then the video of camera 17 to 32 will be displayed on window 1 to 16, and then the video of camera 33 to 34 will be displayed on window 1 to 2.

Steps:

1. Press the *Num + MON* keys to select the output channel.
2. Press the *Num + CAM-G* keys to select the input camera group to be decoded and displayed on the selected output channel.

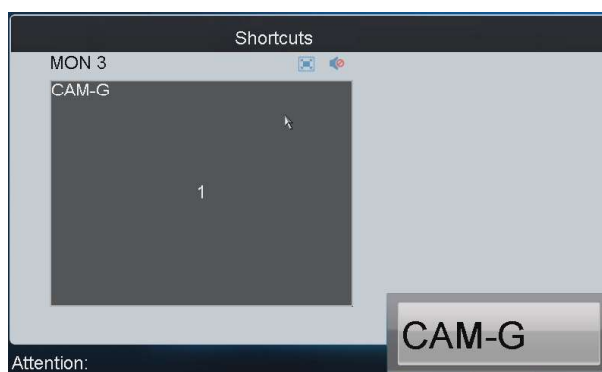

Figure 5.6 Display Video of Camera Group on Output Channel

NOTE

- The dwell time for the cycle view is set in the input group settings interface. You can refer to [Chapter 4.5.4 Setting Input Group](#).
- In the local live view mode, when you input *0+MON* keys, the multi-division display mode is not supported. When you press the *0+CAM* keys, it will stop the dynamic decoding of the current window. If there are more than 1 window of the output channel, the decoding of the 1st window will be stopped by default.
- Corresponding error message will appear on the screen when you perform wrong operation.

5.3.4 Displaying Video of Camera Group to the Window of Output Channel

Purpose:

The video signal from the camera group can be output to and displayed on the selected window of the output channel in cycle.

Steps:

1. Press the *Num + MON* keys to select the output channel.
2. Press the *Num + WIN* keys or directly touch on the screen to select the display window of the output channel.
3. Press the *Num + CAM-G* keys to select the camera group.

Example:

You can press the “1+MON, 2+WIN, 3+CAM-G” keys to decode the video signal from camera group 3 and display it on window 2 of the output channel 1.

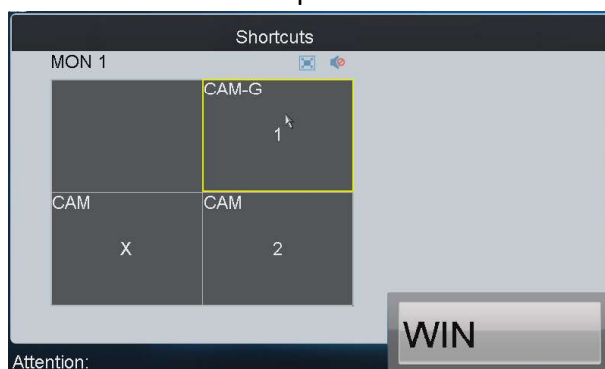

Figure 5.7 Display Video of Camera Group to the Window of Output Channel



NOTE

- The dwell time for the cycle view is set in the input group settings interface. You can refer to [Chapter 4.5.4 Setting Input Group](#).
- In the local live view mode when you press *0+MON* keys, the cycle view function is not supported. When you press the *0+CAM* keys, it will stop the dynamic decoding of the current window. When you press the *0+CAM-G* keys, it will stop the cycle view of the current window.
- Corresponding error message will appear on the lower-left corner of the screen when you perform wrong operation.

5.3.5 Displaying Video of Camera Group to Output Group

Purpose:

The selected camera group signal can be output to and displayed by the output channel group.

1. When the numbers of cameras in the camera group are equal to or less than the numbers of output channels in the output group, e.g., to display the video of 8 cameras to 9 output channels, then the video of each camera will be displayed on its corresponding output channel respectively, e.g., camera 1 on output channel 1, and camera 8 on output channel 8, etc.
2. When the numbers of cameras in the camera group are more than the numbers of output channels in the output group, e.g., to display the video of 34 cameras to 16 output channels, then the video of camera 1 to 16 will be displayed on output channel 1 to 16, the video of camera 17 to 32 on output channel 1 to 16, and then the video of camera 33 to 34 on output channel 1 to 2 in cycle view mode.

Steps:

1. Press the *Num + MON-G* keys to select the output group.
2. Press the *Num + CAM-G* keys to select the camera group to be viewed in cycle on the specified output group.

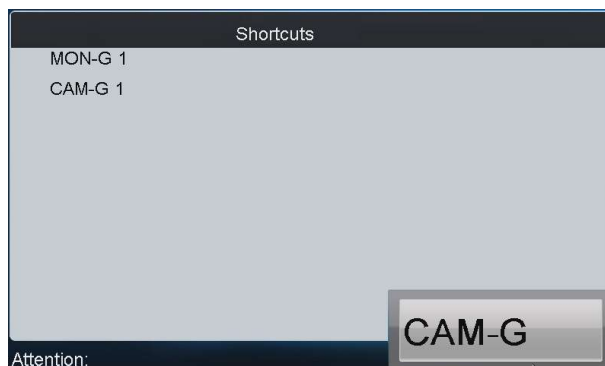

Figure 5.8 Display Video of Camera Group to Output Group

NOTE

- The default dwell time of cycle view is 30s.
- In this operation mode, each output channel in the selected output group will be displayed on the screen in 1-division mode by default.

5.3.6 Displaying Video of Camera Group to the Window Group

Purpose:

In the condition of opening windows first via the iVMS 4200, you can drag the camera group to the window group one-time.

Steps:

1. Press the *Num + MON-G* keys to select the window group.

NOTE

The *Num* should be the integer from 1001 to 1004. 1001 corresponds to the window No. from 1 to 64. 1002 corresponds to the window No. from 65 to 128. The 1003 and 1004 can be done in the same manner.

2. Press the *Num + CAM-G* keys to select the camera group and display the video in cycle to the selected window group.

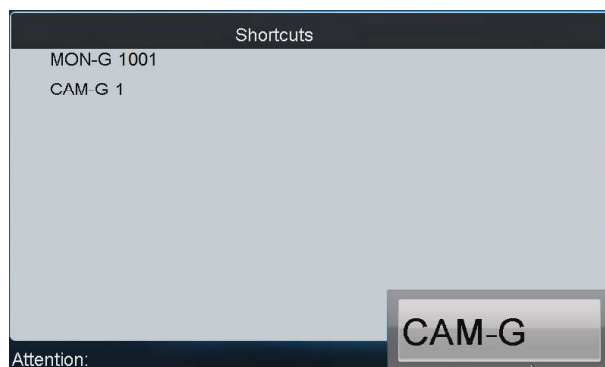

Figure 5.9 Display Video of Camera Group to the Window Group

 **NOTE**

- The dwell time for the cycle view is set in the input group settings interface. You can refer to [Chapter 4.5.4 Setting Input Group](#).
- Corresponding error message will appear on the lower-left corner of the screen when you perform wrong operation.

5.3.7 Setting a Tour

Purpose:

Up to 64 cameras can be set in a tour, with the dwell time configurable. The default dwell time is 30 seconds.

When the system is not in the playback mode, you can directly press the *SET* key then the *Num + TOUR* keys to enter the tour settings interface. Up to 8 tours can be supported currently. The dwell time of the tour is the length of time used for switching from one camera to the next camera in the tour. All cameras are set with the same dwell time.

Steps:

1. Press the *SET* key to enter the tour settings interface.
2. Press the *Num + TOUR* keys to set the selected tour.
3. Press the *Num + ENTER* keys to set the dwell time of the camera.
4. Press the *Num + ENTER* keys to set the camera No..
5. Repeat Step 4 to set other cameras.
6. Press the *SET* key to finish the tour settings.

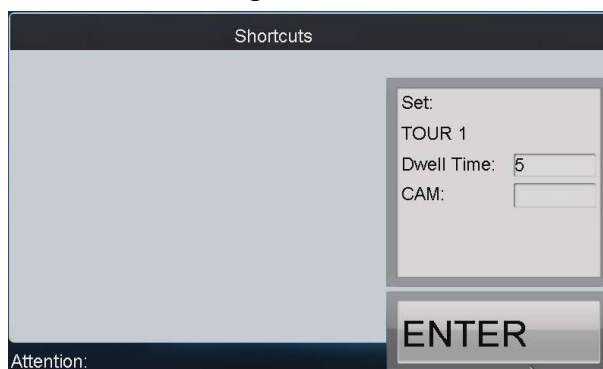

Figure 5.10 Set a Tour

 **NOTE**

- When the device is restarted, all the tour settings will be invalid.
- All configured parameters will be cleared if you press the *Num + TOUR* keys again in the process of setting tour.
- Corresponding error message will appear on the screen when you perform wrong operation.

5.3.8 Calling a Tour

Purpose:

You can call the configured tour on all the windows of the output channel or on the selected sub-window of the output channel.

- **Calling a Tour on All the Windows of the Output Channel**

Steps:

1. Press the *Num + MON* keys to select the output channel for display.
2. Press the *Num + TOUR* keys to call the configured tour to be displayed on the selected output channel.

- **Calling a Tour on the Selected Sub-Window of the Output Channel**

Steps:

1. Press the *Num + MON* keys to select the output channel for display.
2. Press the *Num + WIN* keys to select the sub-window of the output channel for display.
3. Press the *Num + TOUR* keys to call the configured tour to be displayed on the selected sub-window of the output channel.

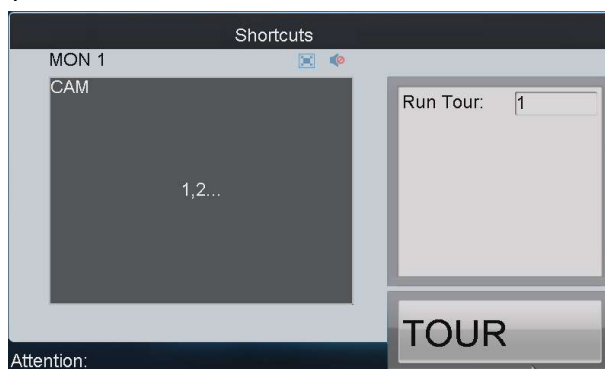

Figure 5.11 Call a Tour

5.3.9 Setting a Group Tour

Purpose:

Multiple camera groups can be displayed on the specified output channels in tour respectively. Each user account is allowed to set up to 8 group tours, and each group can include 8 camera groups to specified output channels.

When the system is not in the playback mode, user can directly press the *SET* key and then *Num + GROUP* keys to enter the group tour settings interface.

Steps:

1. Press the *SET* key to enter the group tour settings interface.
2. Press the *Num + GROUP* keys to set the group tour.
3. Press the *Num + ENTER* keys to set the output channel (MON) No..
4. Press the *Num + ENTER* keys to set the camera group (CAM-G) No..
5. Repeat step 3 and 4 to set other output channels and camera groups.
6. Press the *SET* key to finish the group tour settings.



Figure 5.12 Set Group Tour

NOTE

- The group tour settings will not be saved after keyboard reboot. And if you press the *Num + GROUP* keys in the process of setting the group tours, all previous settings will be cleared.
- Corresponding error message will appear on the screen when you perform wrong operation.

5.3.10 Calling a Group Tour

Purpose:

Multiple camera groups can be automatically displayed on related output channels respectively in tour by calling the configured group tour, e.g., camera group 1 on monitor 1, camera group 2 on monitor 2, etc. The dwell time of group tour can be configured.

Step:

Press the *Num + GROUP* keys to directly call the configured group tour.

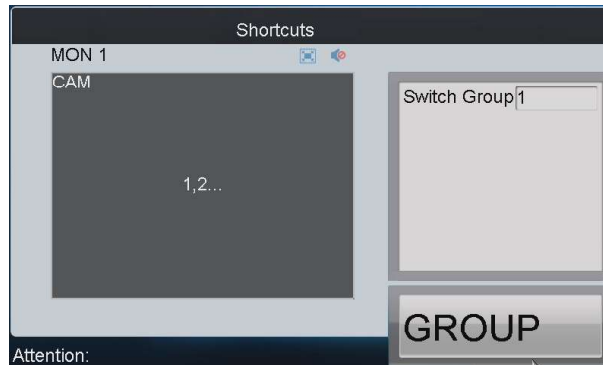

Figure 5.13 Call a Group Tour

NOTE

If multiple camera groups are configured for the same output channel, then it is available for the display of the last configured camera group only.

5.3.11 Operating Instant Playback

Purpose:

The recording files of the previous 5 seconds can be played back via the keyboard instantly.

Steps:

1. Press the *Num + MON* keys to select the output channel.
2. Press the *Num + WIN* keys to select the display window.
3. Press the *Num + CAM* keys to select the camera.
4. Press the  key to enter the instant playback interface.

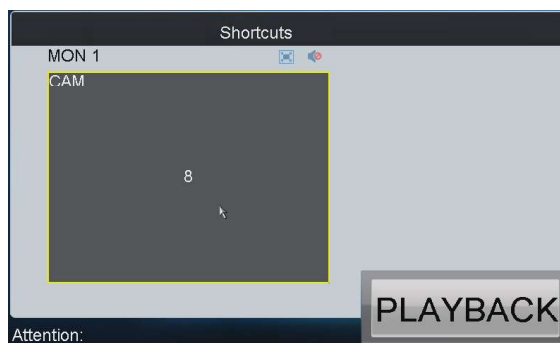



Figure 5.14 Instant Playback

 **NOTE**

- The local playback by time is not supported.
- You can press the  button to stop the instant playback.
- You can also rotate the outer ring of the shutter in clockwise direction to speed up the playback, with the max. speed capable of reaching 16X. And by rotating the outer ring of the shutter in anti-clockwise direction you can speed down the playback, with the min. speed capable of reaching 1/16X.

5.3.12 Switching Video to the Screen

Purpose:

For the decoder such as DS-6400HDI-T and DS-6400HDI-S added to the keyboard, you can configure the screen splicing via the iVMS 4200 client or network keyboard first and switch the video to the screen.

Steps:

1. Press *Num + MON* keys to select the splicing screen of the decoder.

 **NOTE**

The *Num* is the sum of the segment No. of the decoder and the screen No.. For example, the segment No. of the decoder is 3000, and the screen No. is 1, then the *Num* should be 3001.

2. Press *Num + CAM* to switch the video from the selected camera to the selected screen.

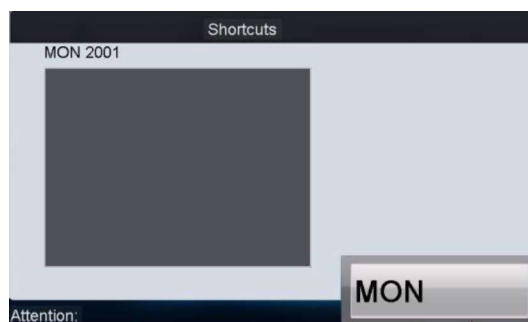

Figure 5.15 Switch the Video to the Screen

5.3.13 Operating Scene Switch

Purpose:

For the B20 MVC, video wall controller, and decoder such as DS-6400HDI-T and DS-6400HDI-S added to the keyboard, you can configure the scene via the iVMS 4200 client first and use the auxiliary keys to switch the scene.

Steps:

3. Set the usage of the Aux Key as the Video Wall/Scene Switch.
Please refer to the *Chapter 4.9.2 Auxiliary Key Settings* for detailed instructions.
4. Check the No. of Video Wall/Scene you want to set.
Please refer to the *Chapter 4.6.4 Setting Video Wall / Scene* for detailed instructions.
5. Press *Num + AUX* keys to select the video wall/scene.

 **NOTE**

The *Num* is the sum of the segment No. and the scene No. on the scene list. For example, the segment No. of B20 MVC is 1000, and the scene No. is 1, then the *Num* should be 1001.

6. Press *Num + MON* keys to select the output channel.
7. Press *Num + WIN* keys to select the screen (not for video wall).
8. Press *Num + CAM/CAM-G* to switch the selected camera or camera group on the screen.
9. Press *0 + CAM* keys to stop decoding.

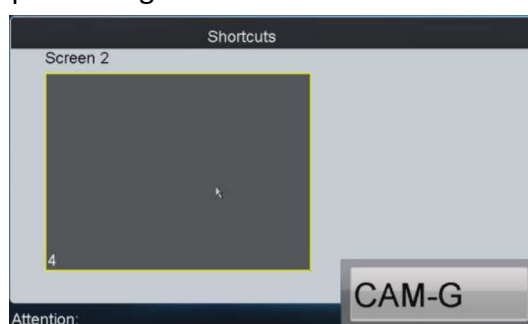

Figure 5.16 Scene Switch

5.4 PTZ Control

5.4.1 Realizing PTZ Control

Purpose:

If the camera connected to the keyboard supports PTZ function, you are allowed to operate the *LIGHT/FOCUS/IRIS/ZOOM/WIPER* buttons to realize PTZ control.

Two options can be used to realize PTZ control.

- **Option 1**

Steps:

1. Press the *Num + MON* keys to select the output channel.
2. Press the *Num + WIN* keys to select the display window.



When the current window is in cycle view mode, the keyboard will be unable to automatically connect with the camera and now it is invalid to operate the joystick.

- **Option 2**

Steps:

1. Press the *Num + CAM* keys to directly select the camera.
2. When the camera connected to the keyboard supports PTZ function, operate the joystick and press *LIGHT/WIPER/FOCUS±/IRIS±/ZOOM* buttons to realize PTZ control.

5.4.2 Setting a Preset

Purpose:

Select the output channel or window and the keyboard is capable of automatically connecting with its corresponding camera. Operate the joystick to move PTZ to the desired position and then press the *PRESET* key to complete the preset settings. You are also allowed to directly select the camera by pressing *Num + CAM* keys and then press the *PRESET* key to start preset settings.

- **Setting a Preset by Output Channel**

Steps:

1. Press the *Num + MON* keys to select the output channel.
2. Press the *Num + WIN* keys to select the display window.
3. Operate the joystick to move PTZ to the desired position.
4. Press the *Num + PRESET* keys to set the current position as the preset with entered number.

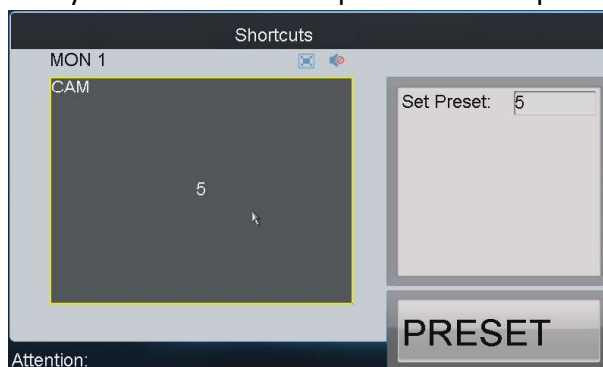

Figure 5.17 Set Preset (1)



NOTE

Corresponding error message will appear on the screen when you perform wrong operation.

- **Setting a Preset by Input Channel**

Steps:

1. Press the *Num + CAM* keys to select the input channel.
2. Operate the joystick to move PTZ to the desired position.
3. Press the *Num + PRESET* keys to set the current position as the preset with entered number.

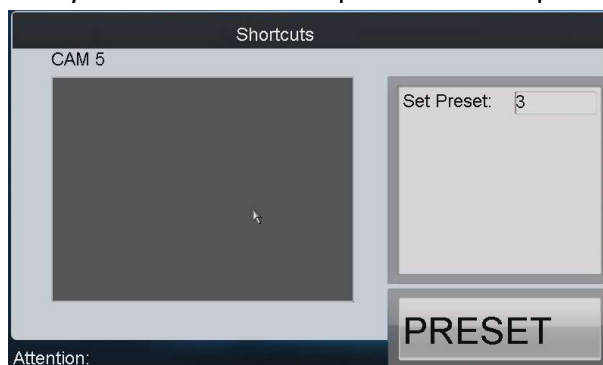

Figure 5.18 Set Preset (2)



NOTE

- It is invalid to press the *0+CAM* keys in the current operation mode.
- Corresponding error message will appear on the screen when you perform wrong operation.

5.4.3 Calling a Preset

Purpose:

The configured preset can be called to achieve the desired position. Select the output channel or window and then press the *CALL* key on the keyboard to call the preset. You are also allowed to directly select the camera by pressing *Num + CAM* keys and then press the *CALL* key to realize preset call.

- **Calling a Preset by Output Channel**

Steps:

1. Press the *Num + MON* keys to select the output channel.
2. Press the *Num + WIN* keys to select the display window.
3. Press the *Num + CALL* keys to call the configured preset.



NOTE

- The operation is valid only when the preset function is supported by the connected camera/dome.
- Corresponding error message will appear on the screen when you perform wrong operation.

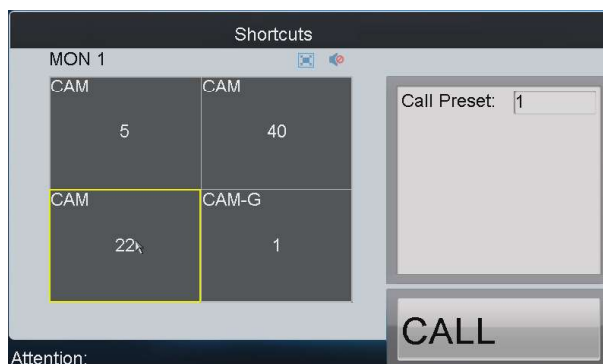

Figure 5.19 Call a Preset (1)

• **Calling a Preset by Input Channel**

Steps:

1. Press the *Num + CAM* keys to select the input channel.
2. Press the *Num + CALL* keys to call the configured preset.

 **NOTE**

- It is invalid to press the *0+CAM* keys in the current operation mode.
- Corresponding error message will appear on the screen when you perform wrong operation.

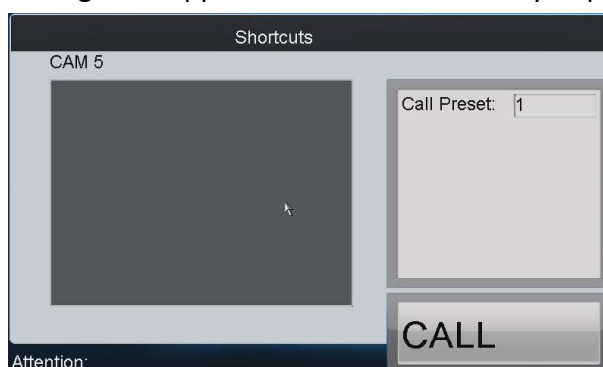

Figure 5.20 Call a Preset (2)

5.4.4 Setting a Patrol

Purpose:

Select the output channel or window and the keyboard is capable of automatically connecting with its corresponding camera. Press the *SET* key on the keyboard and then press *PATROL* key to enter the patrol settings interface. You are also allowed to directly select the camera by pressing *Num + CAM* keys and then press the *SET* key to start patrol settings.

• **Setting a Patrol by Output Channel**

Steps:

1. Press the *Num + MON* keys to select the output channel.
2. Press the *Num + WIN* keys to select the display window.
3. Press the *SET* key to enter the settings interface.
4. Press the *Num + PATROL* keys to enter the patrol settings interface.
5. Press *Num* and press the *ENTER* key to set the preset number, stop time and speed respectively.
6. Repeat Step5 to set other presets.

7. Press the *SET* key again to finish the patrol settings.

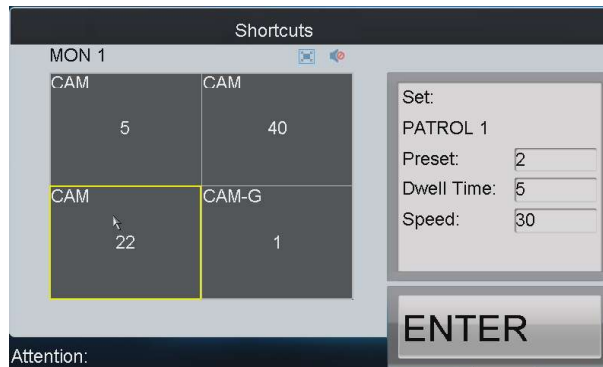

Figure 5.21 Set a Patrol (1)

NOTE

- Corresponding error message will appear on the screen when you perform wrong operation.
- All the configured parameters will be cleared if you press the *Num + PATROL* keys again in the process of setting the patrol.
- **Setting a Patrol by Input Channel**

Steps:

1. Press the *Num + CAM* keys to select the input channel.
2. Press the *SET* key to enter the settings interface.
3. Press the *Num + PATROL* keys to enter the patrol settings interface.
4. Press *Num* and press the *ENTER* key to set the preset number, stop time and speed respectively.
5. Press the *SET* key again to finish the patrol settings.

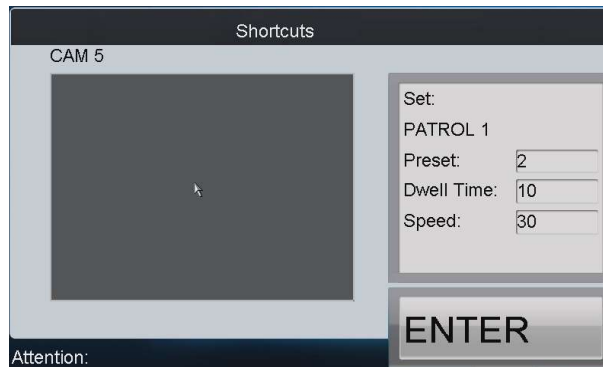

Figure 5.22 Set a Patrol (2)

NOTE

- It is invalid to press the *0+CAM* keys in the current operation mode.
- Corresponding error message will appear on the screen when you perform wrong operation.

5.4.5 Calling a Patrol

Purpose:

Select the output channel or window and the keyboard is capable of automatically connecting with its corresponding camera. Press the *PATROL* key on the keyboard to call the configured patrol. You are also allowed to directly select the camera and then press the *PATROL* key to realize patrol

call.

- **Calling a Patrol by Output Channel**

Steps:

1. Press the *Num + MON* keys to select the output channel.
2. Press the *Num + WIN* keys to select the display window.
3. Press the *Num + PATROL* keys to call the configured patrol.

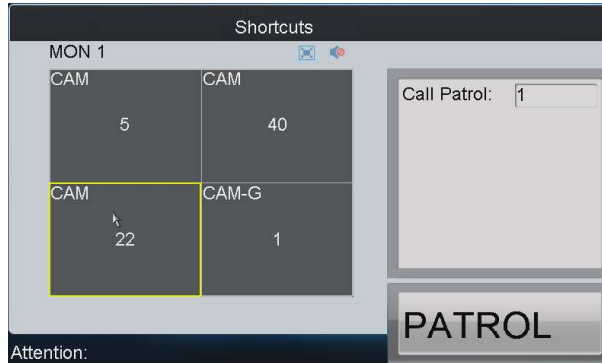

Figure 5.23 Call a Patrol (1)

NOTE

- This operation is valid only when the patrol function is supported by the connected camera/dome.
- Corresponding error message will appear on the screen when you perform wrong operation.

- **Calling a Patrol by Input Channel**

Steps:

1. Press the *Num + CAM* keys to select the input channel.
2. Press the *Num + PATROL* keys to call the configured patrol.

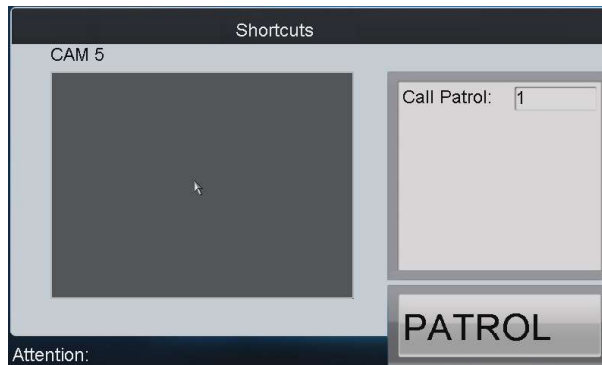

Figure 5.24 Call a Patrol (2)

NOTE

- It is invalid to input the 0+CAM keys in the current operation mode.
- Corresponding error message will appear on the screen when you perform wrong operation.

5.4.6 Setting a Pattern

Purpose:

Select the output channel or window and the keyboard is capable of automatically connecting

with its corresponding camera. Press the *SET* key on the keyboard and then press *PATTERN* key to enter the pattern settings interface. You are also allowed to directly select the camera and then press the *SET* key to start pattern settings.

• **Setting a Pattern by Output Channel**

Steps:

1. Press the *Num + MON* keys to select the output channel.
2. Press the *Num + WIN* keys to select the display window.
3. Press the *SET* key to enter the settings interface.
4. Press the *Num + PATTERN* keys to set the pattern number.
5. Operate the joystick to control PTZ movement.
6. Press the *SET* key again to finish the pattern settings.

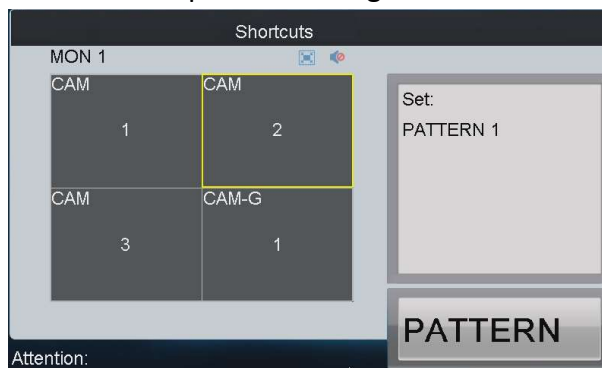

Figure 5.25 Set a Pattern (1)

 **NOTE**

It is invalid to input the *O+CAM* keys in the current operation mode.

• **Setting a Pattern by Input Channel**

Steps:

1. Press the *Num + CAM* keys to select the input channel.
2. Press the *SET* key to enter the settings interface.
3. Press the *Num + PATTERN* keys to set the pattern number.
4. Operate the joystick to control PTZ movement.
5. Press the *SET* key again to finish the pattern settings.



Figure 5.26 Set a Pattern (2)

 **NOTE**

Corresponding error message will appear on the screen when you perform wrong operation.

5.4.7 Calling a Pattern

Purpose:

Select the output channel or window and the keyboard is capable of automatically connecting with its corresponding camera. Press the *PATTERN* key on the keyboard to call the configured pattern. You are also allowed to directly select the camera by pressing *Num + CAM* keys and then press the *PATTERN* key to realize pattern call.

• **Calling a Pattern by Output Channel**

Steps:

1. Press the *Num + MON* keys to select the output channel.
2. Press the *Num + WIN* keys to select the display window.
3. Press the *Num + PATTERN* keys to call the configured pattern.

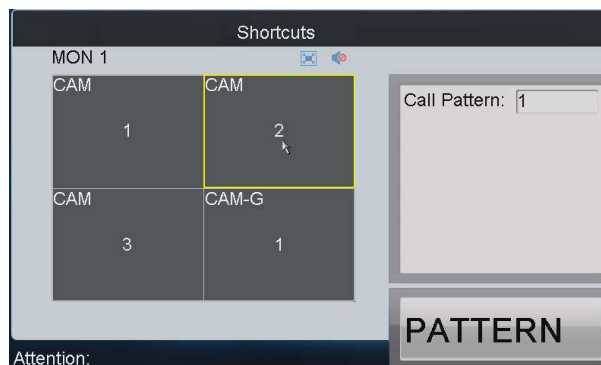

Figure 5.27 Call a Pattern (1)



NOTE

This operation is valid only when the pattern function is supported by the connected camera/dome.

• **Calling a Pattern by Input Channel**

Steps:

1. Press the *Num + CAM* keys to select the input channel.
2. Press the *Num + PATTERN* keys to call the configured pattern.

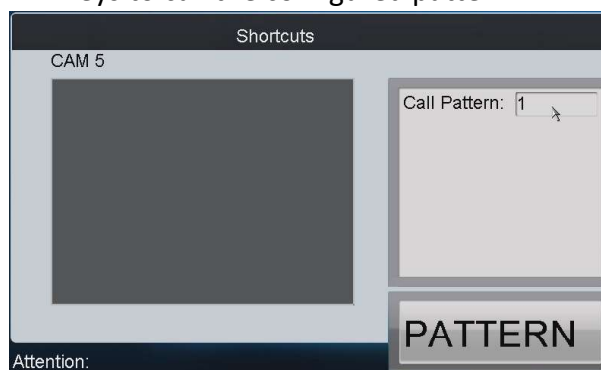

Figure 5.28 Call a Pattern (2)



NOTE

- It is invalid to input the 0+CAM keys in the current operation mode.
- Corresponding error message will appear on the screen when you perform wrong operation.

5.4.8 Calling Pan Scan

Purpose:

Select the output channel or window and the keyboard is capable of automatically connecting with its corresponding camera. Press the *PATTERN* key on the keyboard to call the pan-scan. You are also allowed to directly select the camera by pressing *Num + CAM* keys and then press the *PATTERN* key to realize pan-scan call.

- **Calling Pan-scan by Output Channel**

Steps:

1. Press the *Num + MON* keys to select the output channel.
2. Press the *Num + WIN* keys to select the display window.
3. Press the *PATTERN* key to call the pan-scan.

4. Press the *PATTERN* key again to stop the pan-scan.



NOTE

This operation is valid only when the pattern function is supported by the connected camera/dome.

- **Calling Pan-scan by Input Channel**

Steps:

1. Press the *Num + CAM* keys to select the input channel.
2. Press the *PATTERN* key to call the pan-scan.
3. Press the *PATTERN* key again to stop the pan-scan.



NOTE

- It is invalid to input the 0+CAM keys in the current operation mode.
- Corresponding error message will appear on the screen when you perform wrong operation.

5.5 Auxiliary Functions

The keyboard is designed with *AUX1* and *AUX2* keys on its panel. You are allowed to configure auxiliary functions for *AUX1/AUX2* key on the *operator* user interface. By default settings, the *AUX1* is used for two-way audio and the *AUX2* to picture capture function.

5.5.1 Starting Two-Way Audio

Purpose:

The two-way audio between the keyboard and the currently selected device can be realized through *Aux* key.

- **Start Two-Way Audio with the Output Channel**

Steps:

1. Press the *Num + MON* keys to select the output channel.
2. Press the *AUX1/AUX2* key (configured with the Two-way Audio function) to start two-way audio.

- **Start Two-Way Audio with the Input Channel**

Steps:

1. Press the *Num + CAM* keys to select the input channel.
2. Press the *AUX1/AUX2* key (configured with the Two-way Audio function) to start two-way audio.

- **Stop Two-Way Audio**

During the two-way audio, you can stop it by pressing the *0+AUX1/AUX2* keys.

- **Switch Two-Way Audio with the Nearest Device**

When you press *Num + MON* keys and then press the *AUX1/AUX2* key, it will switch the keyboard to take two-way audio with the nearest device.

- **Start Two-Way Audio with the Camera**

If it needs to take two-way audio with the camera, press the *ESC* key, press the *Num + CAM* keys and then press the *AUX1/AUX2* key to start the two-way audio.



NOTE

- When the network is disconnected in the process of two-way audio, you should press the *0+AUX1/AUX2* keys to stop the two-way audio first and then start it again.
- When you intend to start the two-way audio between the keyboard and the remote device which is taking two-way audio with other device, the error message will appear on the screen.

5.5.2 Capturing Picture

Purpose:

The video picture from the camera can be captured and saved in U-flash disk or uploaded to FTP server through the keyboard operation.

- **Task 1**

Steps:

1. Press the *Num + MON* keys to select the output channel.
2. Press the *Num + WIN* keys to select the display window.
3. Press the *AUX1/AUX2* key (configured with the picture capture function) to start picture capture.

- **Task 2**

Steps:

1. Press the *Num + CAM* keys to select the input channel.
2. Press the central button of the joystick.
3. The captured picture will be uploaded to FTP server (when FTP server is configured) or saved in the local U-flash disk.



NOTE

When the current window is configured with multiple channels for display (in cycle view mode), the error message will appear on the screen as well.

5.5.3 Recording

Purpose:

The video from the camera can be recorded and saved in the local U-flash disk or uploaded to FTP server as well.

- **Task 1**

Steps:

1. Press the *Num + MON* keys to select the output channel.
2. Press the *Num + WIN* keys to select the display window.
3. Press the REC key to start video recording.

- **Task 2**

Steps:

1. Press the *Num + CAM* keys to select the input channel.
2. Press the REC key to start video recording.



NOTE

- During the recording, the REC key on the keyboard lights in red. When you exit the operation interface, the recording continues and you are only allowed to stop it.
- When the window is configured with multiple channels for display (in cycle view mode), the error message will appear on the screen.
- If the current window or output channel is performing playback by time, then the recording operation is not allowed.

5.5.4 Wall Switch

Wall Switch operation only support the B20 V1.6 and B21 V1.4 which support multi video wall Features.

When Auxiliary key is set to **Wall Switch**, when displaying decoded video on output channel, First Press *Num+aux1/aux2* keys to switch to the selected wall.

5.5.5 Other Functions

Purpose:

The *PREV* and *NEXT* keys on the keyboard are used to select the previous or next camera during the shortcut operation.

- **Task 1**

Steps:

1. Press the *Num + MON* keys to select the output channel.
2. Press the *Num + WIN* keys to select the display window.
3. Press the *PREV/NEXT* key to select the previous or next camera.



NOTE

If the current window is not in the dynamic decoding mode, it is invalid to press the *PREV/NEXT* key. When the window is configured with multiple channels for display (in cycle view mode), the error message will appear on the screen.

- **Task 2**

Steps:

1. Press the *Num + CAM* keys to select the input channel.
2. Press the *PREV/NEXT* key to select the previous or next camera.

5.5.6 Access to and operate 256 NVR



Support the decode backboard of High resolution NVR, The operation of decode backboard is similar with DS-69UD, you should configure the window in client ,then control it.

1. Log in the Keyboard as **admin** user, input password and enter the management interface.



Figure 3.38 Admin Main Interface

2. Add NVR in Device Management interface



Figure 2.21 Device List

3. In User Management interface, Set the Related Device is NVR.
4. Log in as operator user, click Input Setting, the all IP channels of NVR are listed here.



Figure 4.87 Input List

- Click Output Setting, all output interface are listed here.

No.	Type	Device	IP Address	Port	Edit	Play
1	HDMI	96256N-24	10.6.11.15	8000		
2	VGA	96256N-24	10.6.11.15	8000		
3	Aux HDV	96256N-24	10.6.11.15	8000		

Figure 4.88 Output list

- Switch input channel to output interface.
 - Press the $i+MON$, $j+MUL$, keys to divide output channel i to j windows.
 - Press the $i+MON$, $j+WIN$, $k+CAM$, keys to display the input channel k to the window j of output channel i .

NOTE

i is the number of NVR output channel showed in the Output list of keyboard. K is the number of NVR input channel showed in the Input list of keyboard. $k=0$ cancel the image display in the window. Click the window area directly can also select the display window.

- You can press $PREV/NEXT$ key to switch the previous or next camera to display on the selected window.

NOTE

- Before you relate the channel to operator, you should configurate all the channels. If you edit, add or delete the IP channel of NVR after you related to operator. It will not update synchronous.
- Switch operation does not guarantee the keyboard and device local live view keep the same. For example, Device has switch the live-view picture to the second screen, but the keyboard still in the first screen.

Chapter 6 Server Operation

6.1 Accessing by MVC

Purpose:

Through the DS-1100KI keyboard, you can configure and control the Multi-function Video Center (MVC).

6.1.1 Login

Steps:

1. Tap the **Server** icon on the startup interface to enter the **Server Login** interface.



Figure 6.1 Startup Interface

2. Select the Login Mode to **MVC/Subdomain/Matrix Access Gate**.
3. On the Login interface, input the IP address, port, user name and password of the MVC.
4. Check the checkbox of **Remember Password** if you want to save the password for future login.



Figure 6.2 Server Login

5. Tap **Login** to enter the MVC interface.

6.1.2 Device List

Steps:

1. Tap the **Device List** tab to enter the **Device List** interface.



Figure 6.3 Device List

- View the information including the device type, IP address and port. The device types in the MVC system are shown as follows:

- M_ENC:** Encoding module
- M_DEC:** Decoding module
- M_CODE:** Code distribution module
- M_CAS_IN:** Input cascading module
- M_CAS_OUT:** Output cascading module
- M_INTEL:** Intelligent module
- M_ALARM:** Alarm module
- V6_DEC:** V6 decoding module
- V6_CAS:** V6 cascading module
- MVC_B10:** MVC B10
- MVC_B11:** MVC B11
- MVC_B12:** MVC B12
- M_DS:** Domain system
- M_SDS:** Sub-domain system
- MATRIX ACCESS GATEWAY:** Matrix access gateway

Editing Device Parameters in Batch

Steps:

- Tap the **Batch Edit IP** button to enter the **Batch Edit** interface.
- Edit the parameters of the encoding/decoding modules, including the start IP, end IP, port, subnet mask and gateway.

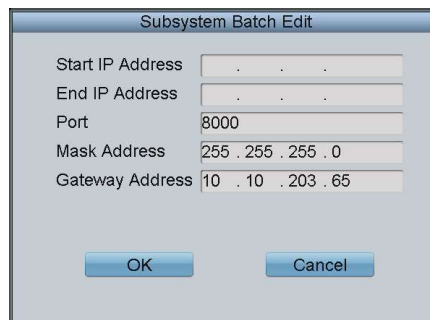



Figure 6.4 Batch Edit

NOTE

- The range from the start IP to end IP must be larger than the number of the functional modules.
- When the NAT function of the system is enabled, it is not allowed to operate the batch edit.

Configuring Encoder/Decoder Parameters

Steps:

1. Tap the  button of an encoder/decoder on the MVC List and enter its settings interface.

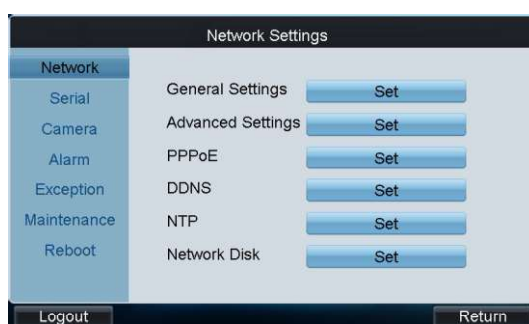

Figure 6.5 Encoder Settings

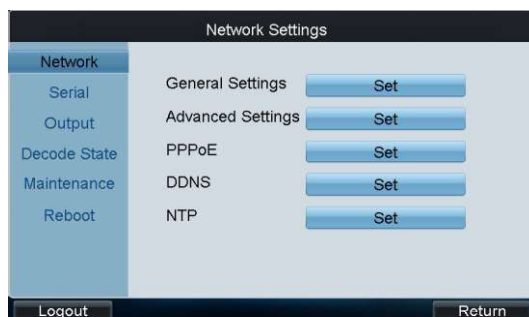

Figure 6.6 Decoder Settings

2. Tap the **Set** button to enter the corresponding settings interface to set the parameters. Please refer to the *Chapter 4.3 Encoding Device Settings* to *Chapter 4.4 Decoding Device Settings* for details.

6.1.3 Camera List

Viewing Camera List

Steps:

1. Tap the **Camera** tab to enter the **Camera List** interface.
2. View the information of all cameras connected to the current MVC system, including the

camera ID, channel No., IP address and port. The No. is used as CAM number in the Shortcut Operation.

No.	Channel	Name	IP Address	Port
1	1	1	172.9.122.100	14600
2	2	2	172.9.122.100	14600
3	3	3	172.9.122.100	14600
4	4	4	172.9.122.100	14600
5	1	1	172.9.122.100	15300
6	2	2	172.9.122.100	15300
7	3	3	172.9.122.100	15300
8	4	4	172.9.122.100	15300

Total 48 items Page 1/6 To 1 P

Logout Input Group

Figure 6.7 Camera List

Setting Input Group

Steps:

1. Tap **Input Group** to enter the **MVC Input Group** interface.
2. Tap  to select the group No. from the drop-down list.
3. Set the Cycle Time (1-65535s) for the current group.

NOTE

The Cycle Time refers to the dwell time defined for each camera in this group.

MVC Input Group Add Camera

Group No. 1 Cycle Time 0 S Save

No.	Channel No.	IP Address	Port
-----	-------------	------------	------

Total 0 items Page 1/1 To 1 P

Delete Exit

Figure 6.8 Set Input Group

4. Tap the **Add Camera** key to enter the **Add Camera** interface:



Figure 6.9 Add Camera

5. Select the cameras from the list to be added to the group, and then tap **Add** to add the selected cameras.
6. You can also set or edit the Cycle Time (1-65535s) for cameras here.
7. Tap **OK** to return to the **MVC Input Group** interface, where you can view the successfully added cameras for the current group.

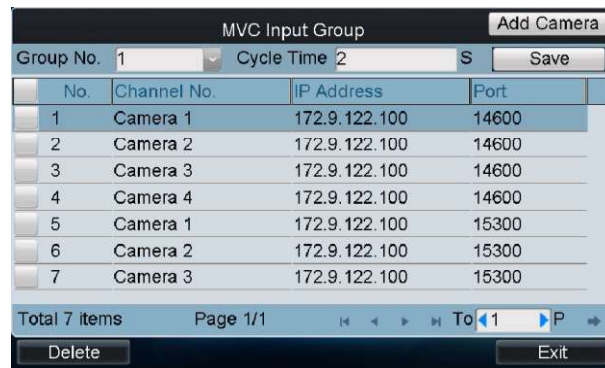

Figure 6.10 MVC Input Group

8. Tap **Save** to save the settings.

6.1.4 Output Channel List

Viewing Output Channel List

Steps:

1. Tap the **Monitor** tab to enter the **Output Channel List** interface.
2. View the information of all monitors connected to the current MVC system, including the output channel No., output type, IP address and port.

No.	Output Type	Name	IP Address	Port	Set
1	DVI1	DVI:1	172.9.122.100	9000	[Set]
2	DVI1	DVI:1	172.9.122.100	9700	[Set]
3	DVI1	DVI:1	172.9.122.100	10400	[Set]
4	DVI1	DVI:1	172.9.122.100	11100	[Set]
5	DVI1	DVI:1	172.9.122.100	11800	[Set]
6	DVI1	DVI:1	172.9.122.100	12500	[Set]
7	DVI1	DVI:1	172.9.122.100	13200	[Set]
8	DVI1	DVI:1	172.9.122.100	13900	[Set]

Total 16 items Page 1/2 To 1 P

Figure 6.11 Output Channel List

Setting Monitor

- **Option 1**

Steps:

1. Tap the button of a monitor from the list to enter the **Monitor Settings** interface.

Figure 6.12 Monitor Settings

2. Configure monitor settings:

Decoding Ability: Set the parameters according to the resolution of the front-end device. If the maximum resolution of the front-end devices connected is 720P, then the Maximum Ability should be set as 720P.

Output Type: Configure the settings according to the mode that is supported by the monitor.

Division Mode: The standard-definition decoding module (BNC output) supports 1 / 4-division mode, while the high-definition decoding module (VGA / DVI / HDMI output) supports 1 / 4 / 9 / 16-division mode.

Enable Audio: To enable the audio output.

Audio Window: Select the window for enabling audio output.

3. Tap **Save** to save the settings.

- **Option 2: Quick Operation of Monitor Settings**

Steps:

1. Press the *Num + MON* keys to select the monitor.
2. Press the *Num + MULT* keys to select the window-division mode on the monitor.

Example: You can press the “2+MON, 16+MULT” keys to realize 16-divison display on monitor 2.

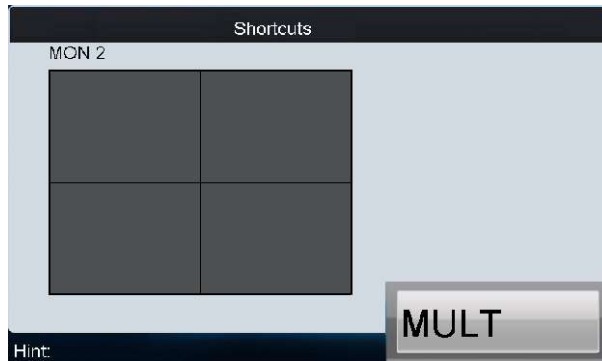



Figure 6.13 Quick Monitor Settings

Setting Output Group

Steps:

1. Tap **Output Group** to enter the **MVC Output Group** interface.
2. Tap  to select the group No. from the drop-down list.

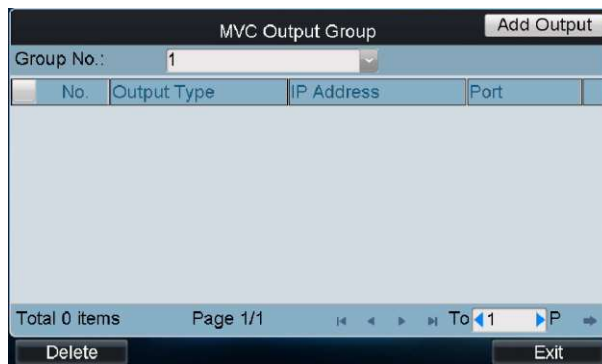

Figure 6.14 Set MVC Output Group

3. Tap the **Add Output** button to enter the **Add Output** interface:

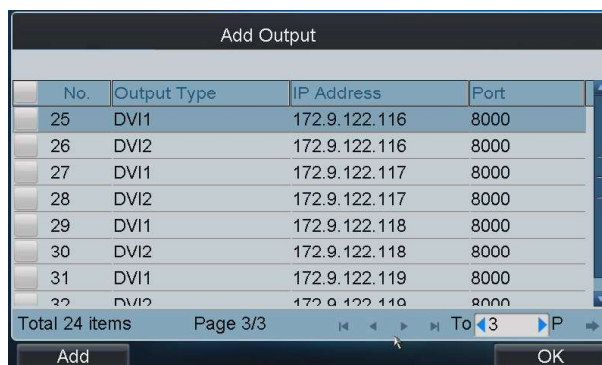

Figure 6.15 Add Output

4. Select the outputs from the list to be added to the group, and then tap **Add** to add them to the group.
5. Tap **OK** to return to the **MVC Output Group** interface, where you can view the successfully

added output channels for the current group.

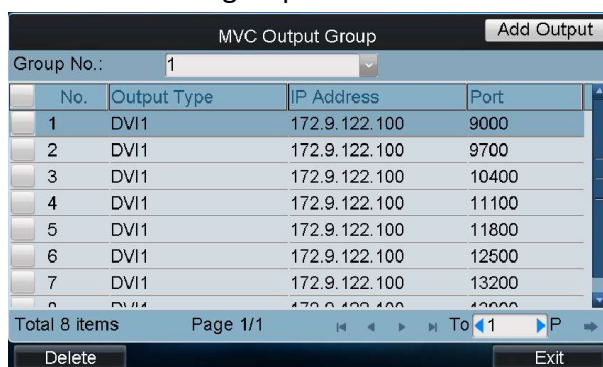

Figure 6.16 MVC Output Group

Displaying Video to Output Channel

You can refer to [Chapter 5.3 Displaying Decoded Video to Output Channel](#) for the operations of displaying video to the output channel.

6.1.5 Scene Settings

Steps:

1. Tap the **Scene** tab to enter the **Scene Settings** interface.

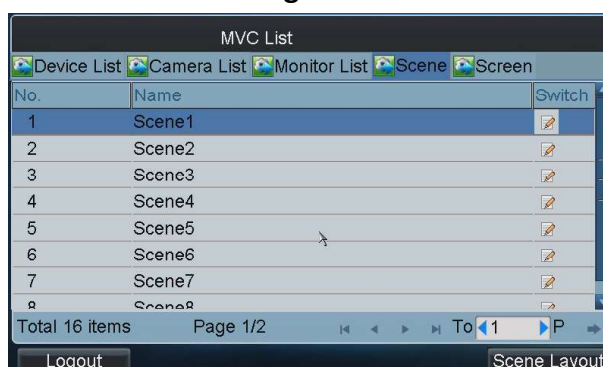



Figure 6.17 Scene Settings

2. Tap  on the list to switch to the selected scene.
3. Tap the **Scene Layout** button to enter the layout of the selected scene.

 **NOTE**

The scene of MVC can be configured on the iVMS-4200 client software.



Figure 6.18 Scene Layout

6.1.6 Screen Settings

Configuring Screen Settings

Steps:

1. Tap the **Screen** tab to configure video display on screen.



Figure 6.19 Screen Settings

2. Select the screen No..
3. Enable the screen splicing by checking the checkbox.
4. Select the screen mode, e.g., 2 x 2.
5. Select the main screen No. which refers to output for image processing.
6. Configure the sub-window settings.
 - (1) Select the sub-screen type to Standard, High Definition or Enhanced High Definition.
 - (2) Select the window, which refers to the sub-window No. of the screen. E.g., if the screen mode is selected to 2 x 2, then the sub-windows can be numbered as 1, 2, 3 and 4.
 - (3) Select the sub-screen No., which refers to the output channel connected to the selected sub-window in Step 6 (2).

 **NOTE**

The Main Screen No. and the Sub-screen No. cannot be the same with each other.

- (4) Repeat the Step 6 (2) ~ (3) to set other sub-windows and their related sub-screen No.
- (5) Tap Save to save the sub-window settings.

7. Tap **Apply** to finish the screen settings.

Setting Base Picture

Purpose:

When the MVC is configured with the enhanced decoder module, you can set the base picture for the screen display.

Before you start:

Put the base picture in the USB-flash disk and insert it into the keyboard.



NOTE

The base picture must be in JPEG format and with the resolution of lower than 3840×1920.

Steps:

1. Enter the **Screen Settings** interface.



Figure 6.20 Screen Settings

2. Tap the **Set Picture** button to enter the **Setting Background Picture** interface.

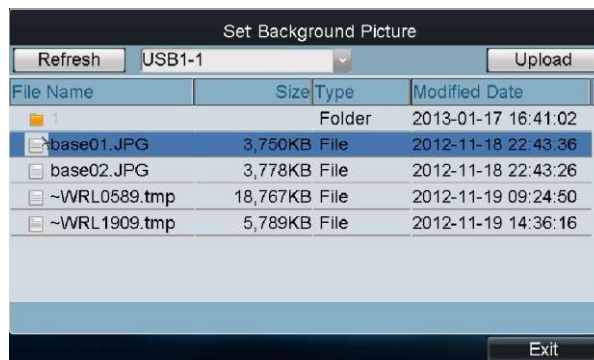

Figure 6.21 Set Background Picture

3. Select the picture file from the directory and tap the **Upload** button to select the layer for the picture.

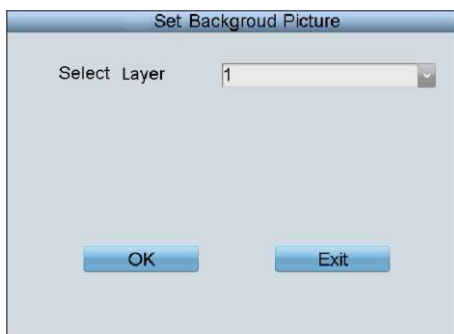

Figure 6.22 Select Layer

4. Select the layer from the drop-down list. Two base pictures can be uploaded.
5. Select **OK** to confirm the base picture settings.
6. On the screen settings interface, tap the **Display/Hide** button to select the layer and enable the configured base picture to be shown on the screen display.

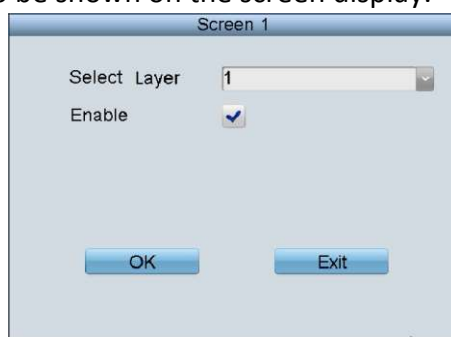

Figure 6.23 Enable Layer

Displaying Video on Normal Video Wall

- **Option 1**

Steps:

1. Press the *Num + MON* keys to select the output channel in the output list.
2. Press the *Num + WIN* keys to or tap the window to select the window of the output channel.
3. Press the *Num + CAM* keys to select the camera.



Figure 6.24 Display Video on Video Wall



The cycle view of displaying the video of the camera group to the selected output channel or output group is supported.

- **Option 2**

Steps:

1. Tap the **Scene Layout** button on the **Scene List** interface to enter the layout of the selected scene.



Figure 6.25 Scene Layout

2. Each yellow grid represents a video wall. Select a grid to enter the **Video Wall Settings** interface.
3. Press the *Num + WIN* keys or tap on the window to select the window No.



Figure 6.26 Select the Window

4. Press the *Num + CAM* keys to select the camera No. for displaying the video on the selected window.

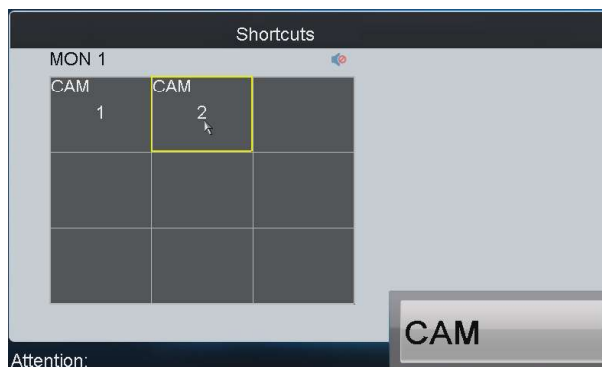

Figure 6.27 Select the Camera

Displaying Video on Splicing Video Wall

- **Option 1**

Steps:

1. Press the *Num + AUX1* keys to select the video wall.
2. Press the *Num + CAM* keys to select the input camera. The number of camera can be viewed from the Camera List.

Example: You can press the “1+AUX1, 3+CAM” keys to view the video signal from camera 3 on the splicing video wall 1.



The multi-division display mode is not supported by the splicing video wall.

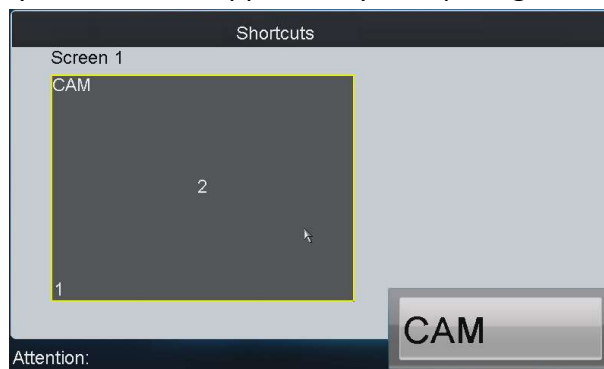

Figure 6.28 Display Video on the Splicing Video Wall

- **Option 2**

Steps:

1. Tap the **Scene Layout** button on the **Scene List** interface to enter the layout of the selected scene.

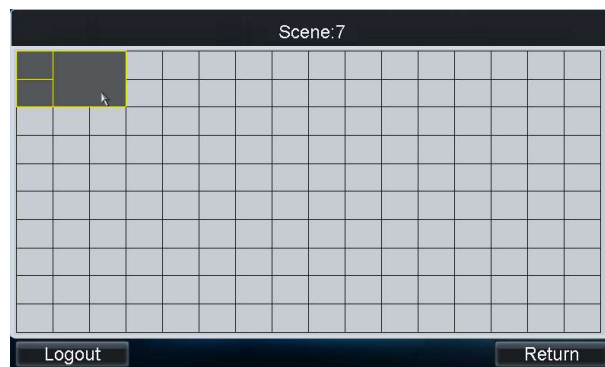

Figure 6.29 Scene Layout

2. Select the splicing video wall.
3. Press *Num + CAM* keys to select the camera for displaying the video on the selected splicing video wall.

Switching Floating Window

Before you start:

Configure the floating settings in the iVMS-4200 client software.

Steps:

1. Press the *Num + AUX1* keys to select the video wall.
2. Press the *Num + WIN* keys to select the roaming window of the video wall.
3. Press the *Num + CAM* keys to select the input camera.
Example: You can press the “1+AUX1, 2+WIN, 3+CAM” keys to display the video signal from camera 3 on the roaming window 2 of video wall 1.
4. You can press the *0+CAM* keys, and it will stop the dynamic decoding of the current camera.

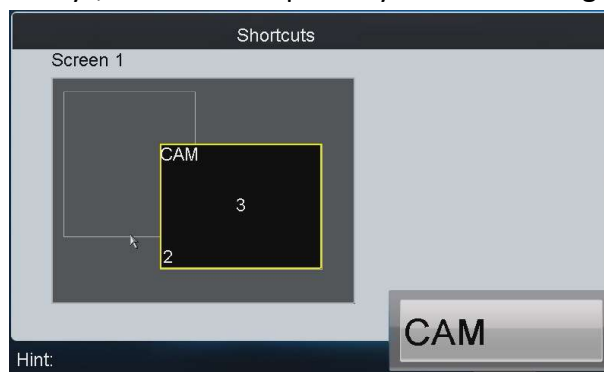

Figure 6.30 Switch Floating Window

6.2 Accessing by Analog Matrix

Purpose:

Through the DS-1100KI keyboard, you can configure and control the analog matrix.

6.2.1 Login

Before you start:

Make sure the analog matrix has been correctly connected to the keyboard before operation.

Steps:

1. Select the login mode to **Analog Matrix** on the **Server Login** interface.

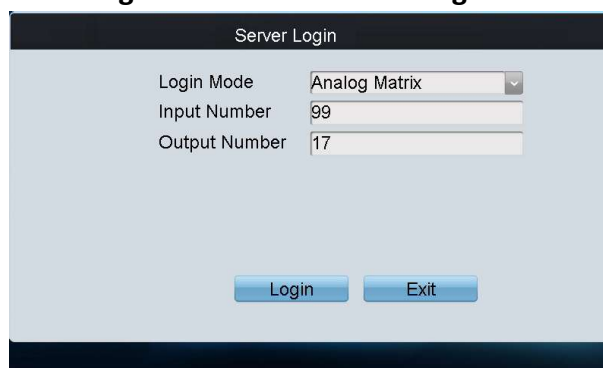

Figure 6.31 Matrix Login

2. Enter the number of video inputs in the **Input Number** field.
3. Enter the number of video outputs in the **Output Number** field.
4. Tap **Login** to log in to the analog matrix system.

6.2.2 Configuring RS-232 Parameters

Purpose:

The RS-232 parameters must be configured the same with that of the connected analog matrix so as to realize the RS-232 communication.

Before you start:

Make sure the RS-232 port of analog matrix and the RS-232 port of keyboard have been connected with the control line.

Steps:

1. Tap **RS232** on the Analog Matrix interface to enter the RS-232 settings interface.



Figure 6.32 Analog Matrix

2. Input the address of the connected analog matrix. Each matrix must be assigned with unique address.
3. Select the baud rate of the connected analog matrix.
4. Set the data bit, stop bit, parity and flow control the same with those of the connected analog matrix.
5. Select the protocol of the connected analog matrix. Currently four protocols are supported: ZT-1.0, ZT-2.0, EXTRON and CREATOR.

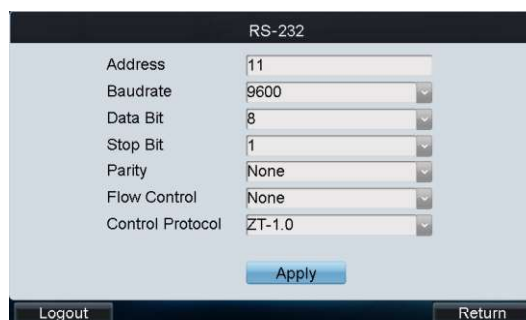

Figure 6.33 Set RS-232 Parameters

6. Tap **Apply** to save the settings.

6.2.3 Operating Analog Matrix

Purpose:

With successful RS-232 communication between the keyboard and the analog matrix, you can

switch the video input to be displayed on the monitor by following the steps below.

Steps:

1. Press the *Num + MON* keys to select the output channel of the analog matrix.
2. Press the *Num + CAM* keys to select the input channel of the analog matrix.



Figure 6.34 Operate Analog Matrix

6.2.4 Configuring RS-485 Parameters

Purpose:

The RS-485 parameters must be configured the same with that of the connected PTZ camera so as to realize the PTZ control.

Before you start:

Make sure the R+ and R- terminals of the PTZ camera has been correctly connected to the T+ and T- terminals of the keyboard.

Steps:

1. Tap **RS485** on the Analog Matrix interface to enter the RS-485 settings interface.



Figure 6.35 Analog Matrix

2. Input the address of the connected PTZ camera. The address ranges from 0~255.
3. Select the baud rate of the connected PTZ camera.
4. Set the data bit, stop bit, parity and flow control the same with those of the connected PTZ camera.
5. Select the protocol of the connected PTZ camera.



Figure 6.36 Set RS-485 Parameters

6. Tap **Apply** to save the settings.
7. You can tap the **Copy All To** button to copy the current RS-485 parameters to other PTZ addresses.

6.2.5 Operating PTZ Control

Operating PTZ Movement

Steps:

1. Press the *Num + CAM* keys to select the connected analog dome or pan/tilt unit.



The *Num* must be the same as the PTZ address.

2. Move the joystick to realize the pan/tilt and lens movement.

Setting/Calling a Preset

• Setting a Preset

Steps:

1. Press the *Num + CAM* keys to select the connected analog dome or pan/tilt unit.
2. Operate the joystick or focus/iris/zoom buttons to move PTZ to the desired position.
3. Press the *Num + PRESET* keys to set the current position as a preset.
4. Repeat step2 and step3 to continue to set the other presets.

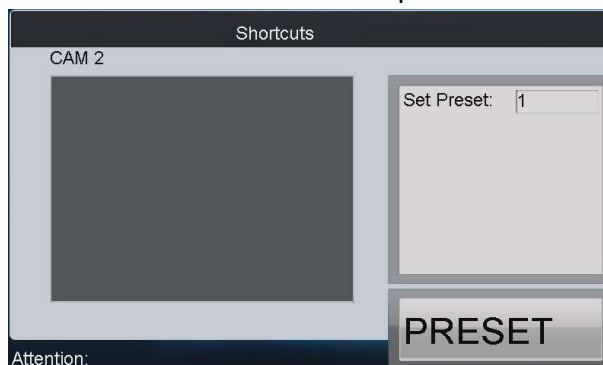

Figure 6.37 Set a Preset

• Calling a Preset

Steps:

1. Press the *Num + CAM* keys to select the connected analog dome or pan/tilt unit.
2. Press the *Num + CALL* keys to call the defined preset.

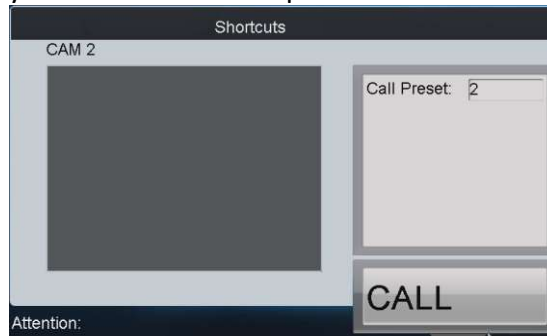

Figure 6.38 Call a Preset

Setting/Calling a Patrol

- **Setting a Patrol**

Steps:

1. Press the *Num + CAM* keys to select the connected analog dome or pan/tilt unit.
2. Press the *SET* key to enter the settings interface.
3. Press the *Num + PATROL* keys to enter the patrol settings interface.
4. Input *Num* and press the *ENTER* key to set the preset number, dwell time and speed respectively.
5. Repeat Step4 to add other presets to the current patrol.
6. Press the *SET* key again to finish the patrol settings.



Figure 6.39 Set a Patrol

- **Calling a Patrol**

Steps:

1. Press the *Num + CAM* keys to select the connected analog dome or pan/tilt unit.
2. Press the *Num + PATROL* keys to call the defined patrol.



Figure 6.40 Call a Patrol

Setting/Calling a Pattern

- **Setting a Pattern**

Steps:

1. Press the *Num + CAM* keys to select the connected analog dome or pan/tilt unit.
2. Press the *SET* key to enter the settings interface.
3. Press the *Num + PATTERN* keys to enter the pattern settings interface.
4. Operate the joystick or focus/iris/zoom buttons to move PTZ to record the pattern.
5. Press the *SET* key again to finish the pattern settings.



Figure 6.41 Set a Pattern

- **Calling a Pattern**

Steps:

1. Press the *Num + CAM* keys to select the connected analog dome or pan/tilt unit.
2. Press the *Num + PATTERN* keys to call the defined pattern.

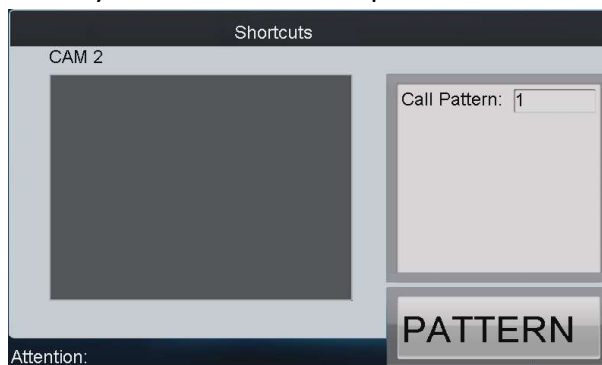

Figure 6.42 Call a Pattern

6.3 Accessing by Matrix Access Gateway

Purpose:

Through the DS-1100KI keyboard, you can configure and control the matrix access gateway.

6.3.1 Login

Steps:

5. Select the login mode to **Matrix Access Gateway** on the **Server Login** interface.

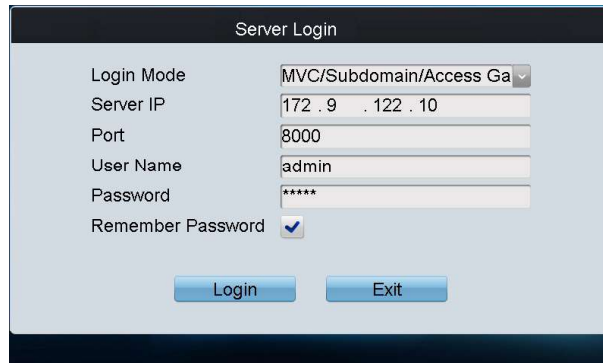

Figure 6.43 Matrix Access Gateway Login

6. Input the IP address, port, user name and password.
7. Check the checkbox of **Remember Password** if you want to save the password for future login.
8. Tap **Login** to log in to the Matrix Access Gateway interface.

6.3.2 Operating Matrix Access Gateway

Purpose:

You can switch the video input to be displayed on the monitor by following the steps below.

Steps:

1. Press the *Num + MON* keys to select the output channel of the analog matrix.
2. Press the *Num + CAM* keys to select the input channel of the analog matrix.

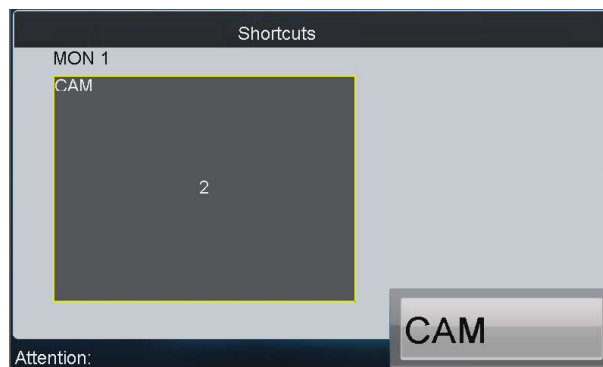

Figure 6.44 Operate Analog Matrix

6.3.3 Operating PTZ Control

Steps:

1. Press the *Num + CAM* keys to select the connected camera or pan/tilt unit.



The *Num* must be the same as the PTZ address.

2. Move the joystick to realize the pan/tilt and lens movement. Refer to [Chapter 6.2.5 Operating PTZ Control](#) for the detailed operations of PTZ control.

Accessing by iVMS Platform

6.4 Accessing by iVMS Platform

Purpose:

Through the DS-1100KI keyboard, you can get access to the iVMS 5200 platform and HikCentral platform.

Before you start:

Please make proper configuration on the iVMS 5200 platform or HikCentral platform before connecting the keyboard to the iVMS server. Please refer to the user manual of corresponding iVMS platform for instructions.

6.4.1 Logging in to the iVMS Platform

Steps:

1. On the Server Login interface, select the Login Mode to iVMS Platform.
2. Enter the Server IP, Port, login User Name and Password.
3. Tap **Login** to log in to the platform.



Figure 6.45 iVMS Platform Login

6.4.2 Managing Input Channel

Purpose:

The corresponding input channel corresponds to the Index No. on the **Control Center Unit List** interface of the keyboard. You can modify the keyboard No. of the input channel via the iVMS platform.

Index	Name	Type	Enter
2	AAA	Sub Control Cente	
3	BBB	Sub Control Cente	
1	A	Region	
2	B	Region	
120530034140073190	123	Screen Group	
112	109Channel1	Input	
12060404594398402	109Channel2	Input	

Total 7 items Page 1/1 To 1 P

Logout Refresh

Figure 6.46 Control Center Unit List

Steps:

1. On the iVMS platform, click **Logical View** and select an added device from the left Control Center.
2. Click **Camera** under the selected device to enter the **Camera List** interface.

Name	Device	Area Name	Stream Type	Protocol Type
IP Camera33_NVR_test	NVR_test	NVR_test	Main Stream	TCP
IP Camera34_NVR_test	NVR_test	NVR_test	Main Stream	TCP

Figure 6.47 Camera List

3. Select a camera from the list and click it to enter the **Camera Information** interface to modify the keyboard No. in the **Keyboard No.** text filed.

IP Camera33_NVR_test

Camera Information

* Camera Name

* Stream Type

* Protocol Type

Keyboard No.

Save Back

Figure 6.48 Modify Camera

6.4.3 Managing Output Channel

Steps:

1. Log in to the iVMS platform, and add a video wall. Link the decoding output with the video wall.

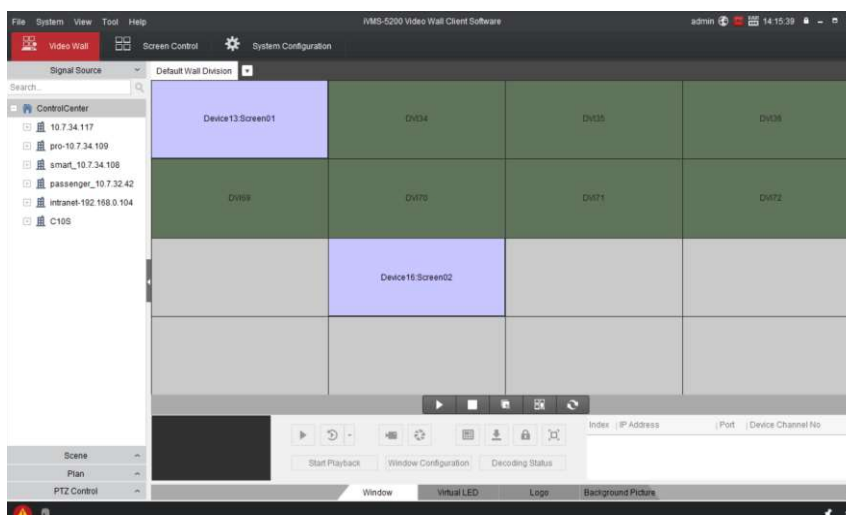

Figure 6.49 Monitor Screen Group

2. After the configuration of the video wall via the iVMS platform, the screen No. will be displayed on the corresponding decoding channel.

6.4.4 Displaying Video on Video Wall

Purpose:

You can follow the steps below to view the video from a camera on the selected screen.

Steps:

1. Press the *Num + MON* keys on the keyboard to select the screen you have configured via the iVMS platform.
2. Press the *Num + WIN* keys on the keyboard to select the display window on the selected screen.
3. Press the *Num + CAM* keys on the keyboard to select the input channel which has been configured the keyboard No. via the iVMS platform for displaying on the selected window.
For example, you can press “*1 + MON, 1+WIN, 1+CAM*” to display the video from camera 1 to the window 1 of the screen 1.



Figure 6.50 Display Video on Video Wall

NOTE

- For the single-division display mode, step 2 is not needed; the window-division display mode must be configured via the iVMS platform.
- You can press *PREV/NEXT* key to switch the previous or next camera to display on the selected window.

6.4.5 Switching the Scene

Steps:

1. On the **Control Center Unit List** interface after login, tap the  icon of the video wall item to enter the Default Wall Division Unit List interface.

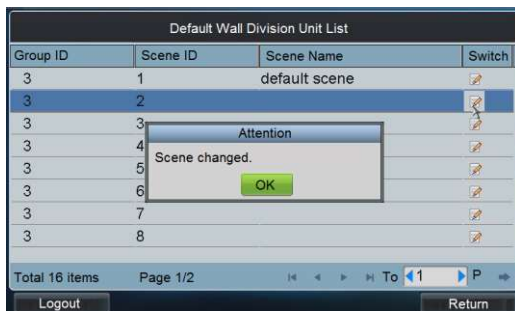



Figure 6.51 Default Wall Division Unit List

2. Tap the  icon to switch the selected scene. The “Scene changed.” attention box will pop up if the switching is succeeded.

Chapter 7 Keyboard Configuration by WEB Server

Purpose:

You are also allowed to configure the keyboard parameters by WEB server.

7.1 Configuring by Admin

7.1.1 Login

Steps:

1. Open WEB browser. Input the IP address of the keyboard (e.g., `http://172.6.24.64`) and click Enter.
2. The system pops up a login interface. Input the User Name (*admin*) and remain the password empty.

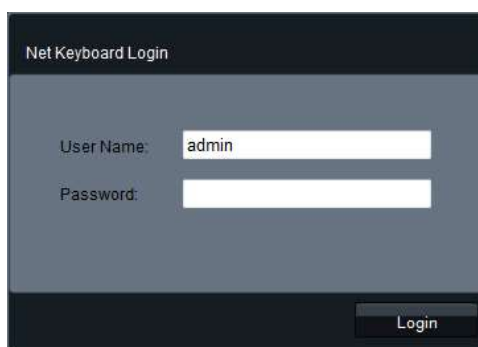

Figure 7.1 User Login

3. Click **Login** and you are reminded to activate the keyboard and reset the *admin* password.

STRONG PASSWORD RECOMMENDED—We highly recommend that you create a strong password of your own choosing (using a minimum of 8 characters, including upper case letters, lower case letters, numbers, and special characters) in order to increase the security of your product. We recommend that you reset your password regularly, especially in the high security system, resetting the password monthly or weekly can better protect your product.

4. Input the New Password and Confirm the password. Tap **OK** to return to the **Login** interface.
5. Input the new password and tap **Login** to enter the main interface.

NOTE

For the *admin*, if you have input the wrong password for 7 times, the keyboard will be locked for 30 minutes.

7.1.2 Keyboard Management

Steps:

1. Click **Keyboard** on the left navigation bar to enter the Keyboard Management interface:

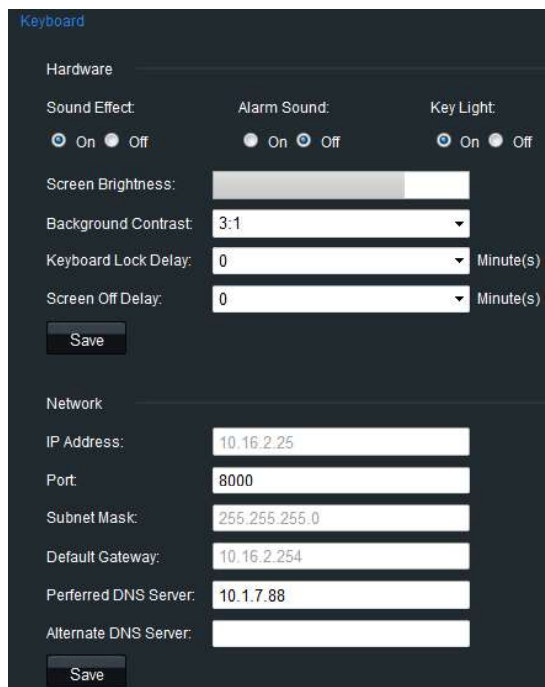

Figure 7.2 Keyboard Management

2. On this interface, you can configure the hardware and network parameters of the keyboard.
3. After configuration, click **Save** to save the settings.

7.1.3 User Management

Steps:

1. Click **User** on the left navigation bar to enter the User Management interface:



Figure 7.3 User Management

2. On this interface, you can add, edit or delete the user account and assign the devices to the added operators.

● Adding a User

Steps:

- 1) Click the **Add** button to enter the Add User interface.
- 2) Input the User Name, Password and Confirm the password to create a new user account.

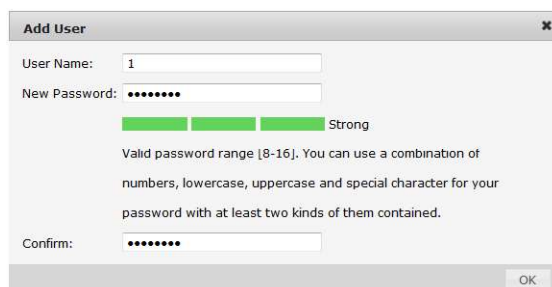

Figure 7.4 Add User

- 3) Click **OK** to save the settings.

STRONG PASSWORD RECOMMENDED—We highly recommend that you create a strong password of your own choosing (using a minimum of 8 characters, including upper case letters, lower case letters, numbers, and special characters) in order to increase the security of your product. We recommend that you reset your password regularly, especially in the high security system, resetting the password monthly or weekly can better protect your product.



If you have input a password which is risky, when you click **OK** to save it, the attention message “The password does not meet password strength need!” will pop up. You have to change a stronger password or you cannot add the user.

● Editing a User

Steps:

- 1) Select a user from the list and click the  icon to enter the Change Password interface.
- 2) Input the New Password and Confirm it.

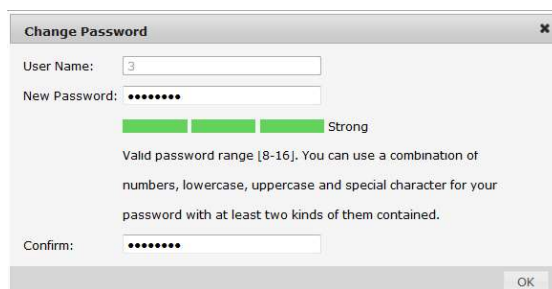

Figure 7.5 Change Password

- 3) Click **OK** to save the settings.



If you have input a password which is too simple, when you click **OK** to save it, the attention message “The password does not meet password strength need!” will pop up. You have to change a stronger password or you cannot edit it.

● Deleting a User

Steps:

- 1) Select a user from the list and click the  icon.

- 2) In the pop-up message box, click **OK** to delete the selected user account.

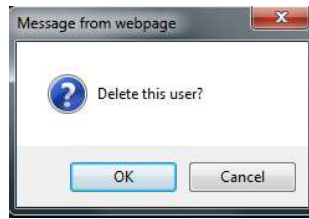



Figure 7.6 Delete User

● Setting Operator Device

Steps:

- 1) Select an *operator* from the list and click the  button to enter the User-Device interface.

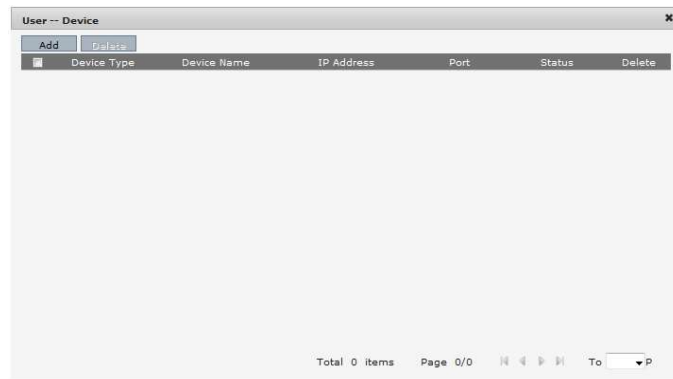

Figure 7.7 User-Device

- 2) Click **Add** to enter the User-Add Device interface on which it displays all devices already added to the keyboard by *admin*.

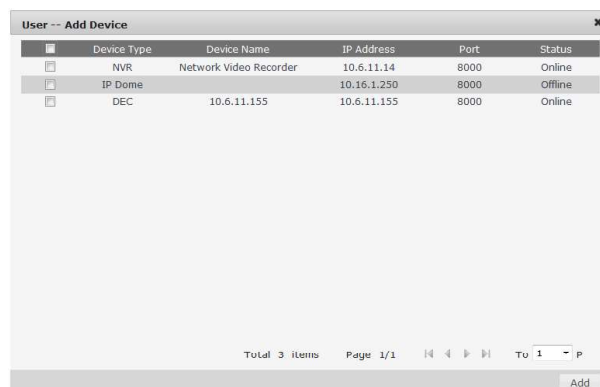

Figure 7.8 Add Device

- 3) Select the device (s) from the list and then click **Add** button to finish the adding of device (s) for the current user.
- 4) On the User-Device interface, you can view the successfully added devices for the current user.

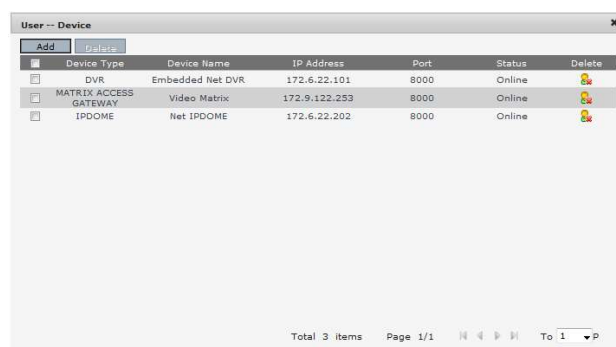

Figure 7.9 Added Device List

- 5) You can also select the device from the list and click the icon to delete it.

7.1.4 Device Management

Steps:

1. Tap **Device** on the left navigation bar to enter the **Device Management** interface.

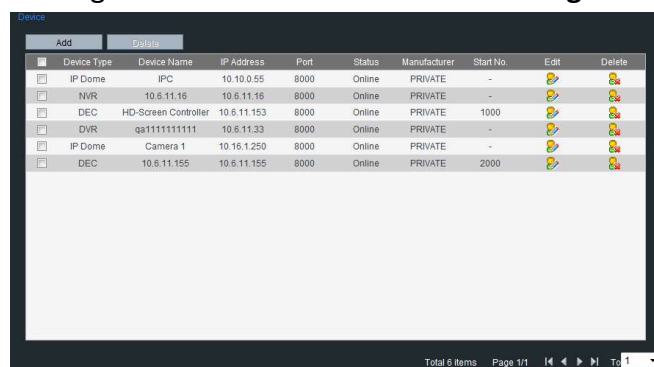

Figure 7.10 Device Management

2. On this interface, you can add, edit or delete the device.

- **Adding a Device**

Steps:

- 1) Tap **Add** to enter the **Add User** interface.
- 2) Input the name, IP, port and login user name/password of the device to add.
- 3) Tap **OK** to finish the adding of the device. The successfully added devices will be displayed on the list of **Device Management** interface.

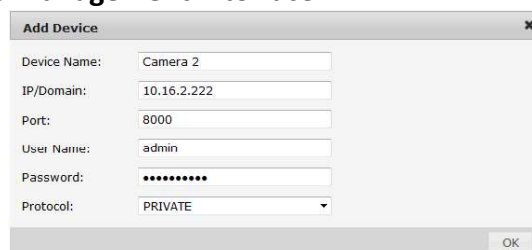



Figure 7.11 Add Device

- **Editing a Device**

Steps:

- 1) Select a device from the list and tap the  icon to enter the **Edit Device** interface.
- 2) Edit the Device Name, Port, User Name, Password, and Protocol.
- 3) Tap **OK** to save the parameters.

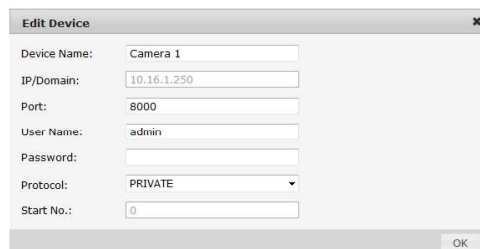



Figure 7.12 Edit Device

- **Deleting a Device**

Select a device from the list and tap the  icon to delete it.

7.1.5 Importing/Exporting Camera List

Purpose:

You can import the camera list in the format of .xls in the PC to the keyboard or export the camera information of the keyboard to the PC.

Click the **Import/Export Camera List** tab on the left navigation bar to enter the **Import/Export Camera List** interface.



Figure 7.13 Import/Export Camera List

- **Importing Camera List**

Steps:

- 1) Click **Browse** to select the camera list file directory in the pop-up window.
- 2) Click the **Import** button to import the camera list in the PC to the keyboard.

- **Exporting Camera List**

Steps:

- 1) Click the **Export** button and the **Select User** window pops up.



Figure 7.14 Select User

- 2) Select the user from the drop-down list.
- 3) Click **OK** to export the camera list of the selected user to the PC.

7.1.6 Maintenance

- **Checking Device Working Status**

Steps:

- 4) Tap the **Work Status** on the left navigation bar to enter the **Working Status** interface.
- 5) Check the working status of the keyboard.

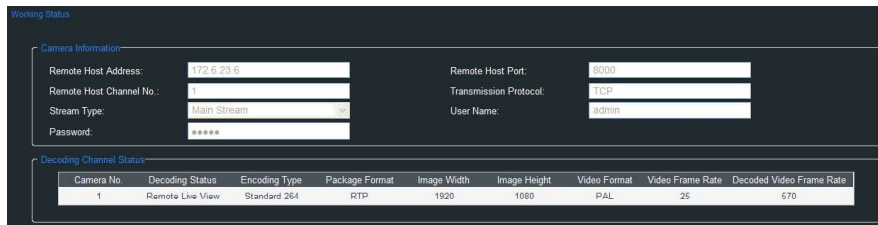

Figure 7.15 Check Working Status

- **Restoring Default Settings**

Steps:

- 1) Tap the **Restore Default** on the left navigation bar to enter the **Restore Default** interface.

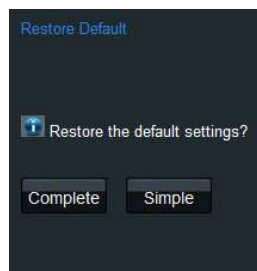

Figure 7.16 Restore Default Settings

- 2) Select the default type on your demand. **Complete** and **Simple** are selectable. Please refer to [Chapter 3.7 Restoring to Default Settings](#) for the details of two default types.

- **Importing/Exporting Configuration File**

Steps:

- 1) Tap the **Import/Export Config. File** on the left navigation bar to enter the **Configuration File Management** interface.

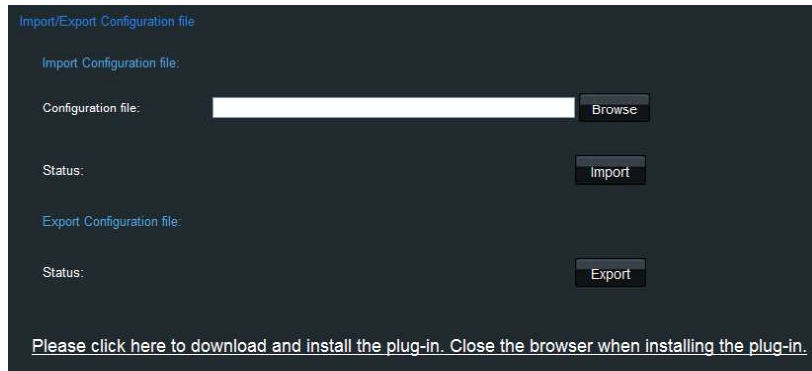

Figure 7.17 Import/Export Configuration File

- 2) To import the configuration file, tap the **Browse** button and specify the directory of the file in the pop-up box, and tap the **Import** button.
- 3) To export the configuration file, tap the **Export** button and specify the saving directory of the exported file.

 **NOTE**

For the first time use of the import/export configuration file function, a plug-in needs to be installed. A hint will appear on the lower-half of the screen: "Please tap here to download and install the plug-in. Close the browser when installing the plug-in." Tap the hint and follow the pop-up instruction to install the plug-in.

• **Upgrading**

Steps:

- 1) Tap the **Upgrade** on the left navigation bar to enter the **Upgrade** interface.



Figure 7.18 Upgrade

- 2) Tap the **Browse** to select the upgrade file directory in the pop-up box.
- 3) Tap the **Upgrade** button to upgrade the keyboard.

7.2 Configuring by Operator

7.2.1 Login

Steps:

1. Open WEB browser. Input the IP address of the keyboard (e.g., <http://172.6.24.64>) and click Enter.
2. The system pops up a login interface. Input the User Name (*operator*) and Password.

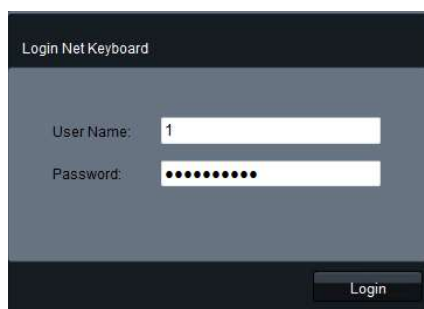

Figure 7.19 Operator Login

3. Click **Login** to log in to the keyboard.

 **NOTE**

For the *operator*, if you have input the wrong password for 5 times, the keyboard will be locked for 30 minutes.

7.2.2 Device Management

Steps:

1. Tap the **Device List** on the left navigation bar to enter the **Device Management** interface.



Figure 7.20 Device Management

2. Select an encoding device and tap the  icon to enter the **Stream Media** interface to configure stream media for the device.

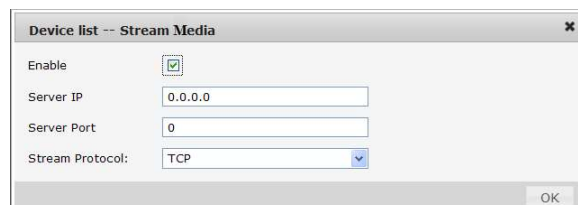

Figure 7.21 Stream Media Settings

3. Check the checkbox of **Enable** to enable the stream media.
4. Input the Server IP, Server Port and select the Server Protocol.
5. Tap **OK** to save the settings.

7.2.3 Input Settings

Steps:

1. Tap **Input Settings** on the left navigation bar to enter the **Input Settings** interface:

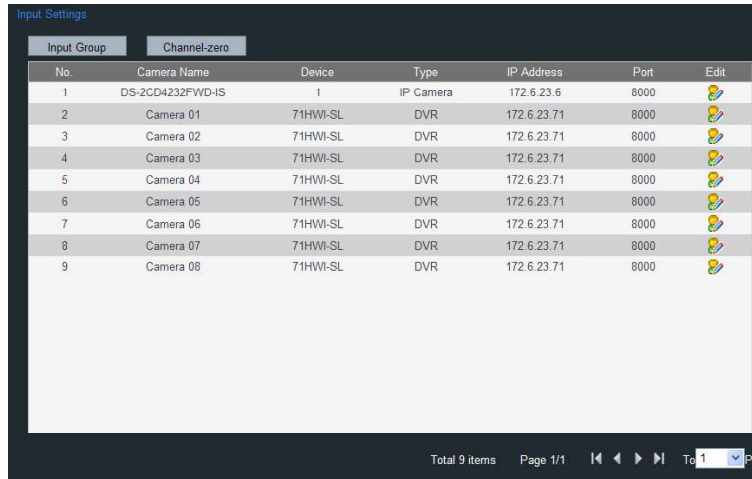

Figure 7.22 Input Settings

2. You can edit the camera, add cameras to input groups and view the cameras supporting channel-zero.

- **Editing a Camera**

Steps:

- 1) Select a camera from the list and tap the icon to enter the **Edit Camera** interface.
- 2) You can edit its name, No., protocol and stream type.



Figure 7.23 Edit Camera

- **Setting an Input Group**

Steps:

- 1) Tap the **Input Group** button to enter the **Input Group** interface.



Figure 7.24 Input Group

- 2) Select the Group No. and edit the cycle time in the given text filed, and tap **Set** button.

- 3) Tap the **Add Camera** button to enter the **Add Camera** interface:
- 4) Select the cameras from the list to be added to the group, and then tap **Add**.

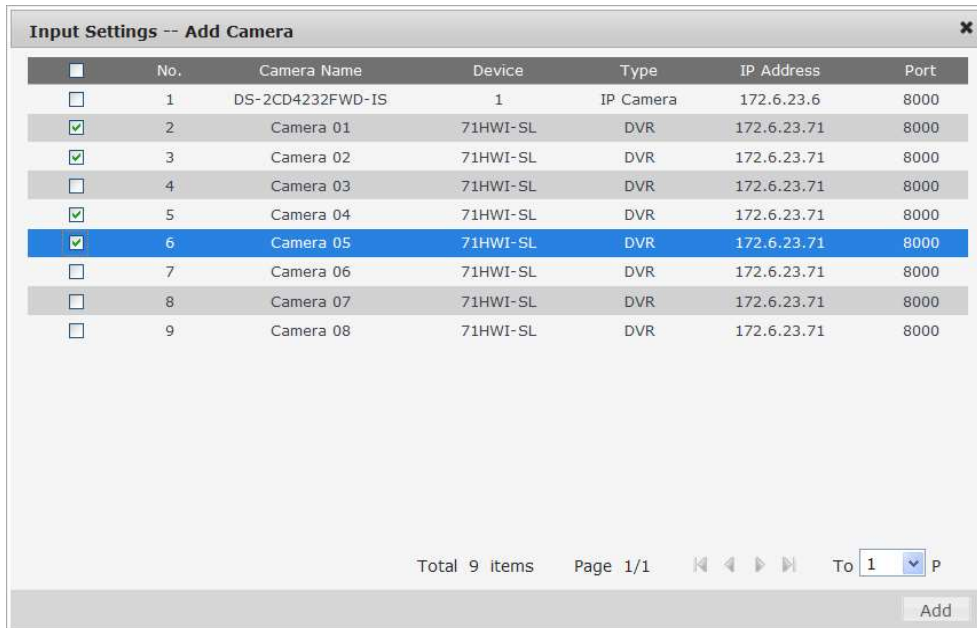

Figure 7.25 Add Camera

- 5) Return to the **Input Group** interface, and you can view the successfully added cameras for the current group.

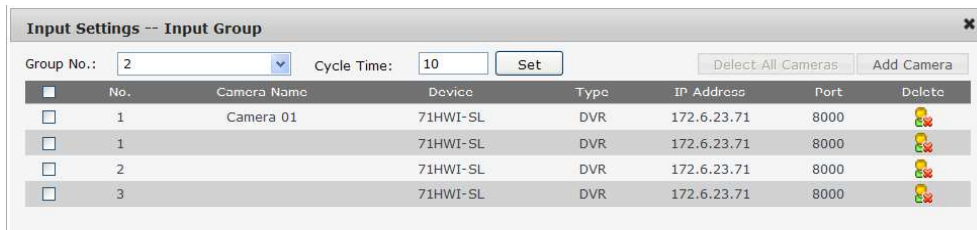

Figure 7.26 Input Group

- **Viewing Cameras Supporting Channel-Zero**

Tap the **Channel-zero** button to show the list of devices which support the Channel-zero function.

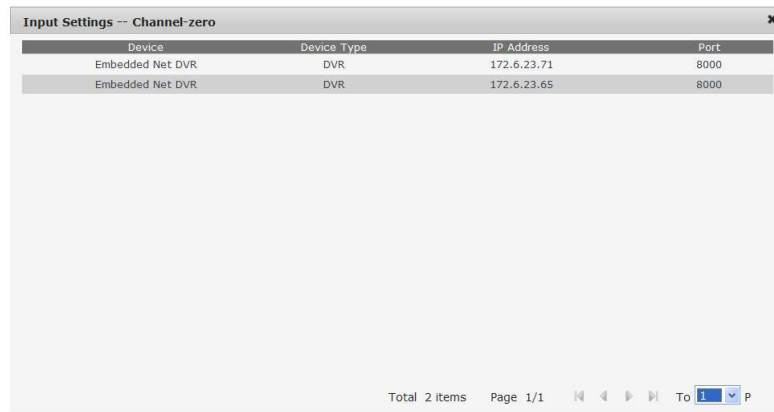
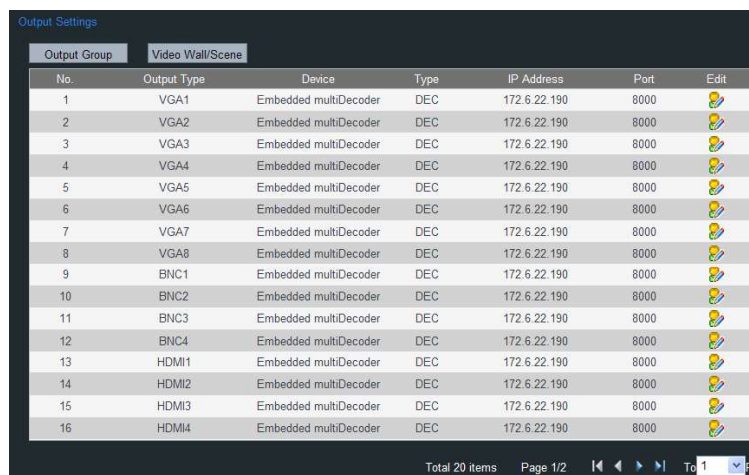

Figure 7.27 List of Cameras Supporting Channel-Zero

7.2.4 Output Settings

Steps:

1. Tap **Output Settings** on the left navigation bar to enter the **Output Settings** interface.



No.	Output Type	Device	Type	IP Address	Port	Edit
1	VGA1	Embedded multiDecoder	DEC	172.6.22.190	8000	
2	VGA2	Embedded multiDecoder	DEC	172.6.22.190	8000	
3	VGA3	Embedded multiDecoder	DEC	172.6.22.190	8000	
4	VGA4	Embedded multiDecoder	DEC	172.6.22.190	8000	
5	VGA5	Embedded multiDecoder	DEC	172.6.22.190	8000	
6	VGA6	Embedded multiDecoder	DEC	172.6.22.190	8000	
7	VGA7	Embedded multiDecoder	DEC	172.6.22.190	8000	
8	VGA8	Embedded multiDecoder	DEC	172.6.22.190	8000	
9	BNC1	Embedded multiDecoder	DEC	172.6.22.190	8000	
10	BNC2	Embedded multiDecoder	DEC	172.6.22.190	8000	
11	BNC3	Embedded multiDecoder	DEC	172.6.22.190	8000	
12	BNC4	Embedded multiDecoder	DEC	172.6.22.190	8000	
13	HDMI1	Embedded multiDecoder	DEC	172.6.22.190	8000	
14	HDMI2	Embedded multiDecoder	DEC	172.6.22.190	8000	
15	HDMI3	Embedded multiDecoder	DEC	172.6.22.190	8000	
16	HDMI4	Embedded multiDecoder	DEC	172.6.22.190	8000	

Figure 7.28 Output Settings

2. You can edit the output channel, add output channels to output groups and set video wall or scene.

- **Editing an Output Channel**

Steps:

- 1) Select an output channel from the list and tap the icon to enter the Edit Output interface.
- 2) You can edit its output No..

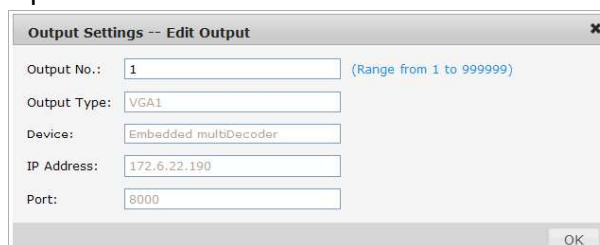

Output Settings -- Edit Output ✕

Output No.: (Range from 1 to 999999)

Output Type:

Device:

IP Address:

Port:

Figure 7.29 Edit Output Channel

- **Setting an Output Group**

Tap the **Output Group** button to enter the **Output Group** interface to add an output group. Please refer to the same operating steps in [Chapter 7.2.3 Setting an Input Group](#) section.

- **Setting Video Wall/Scene**

Steps:

- 1) Tap the **Video Wall/Scene** button to enter the **Video Wall/Scene Setting** interface.

No.	Name	Device Name	IP Address	Port	Edit
1	Video Wall 01	Embedded multiDecoder	172.6.22.190	8000	
2	Video Wall 02	Embedded multiDecoder	172.6.22.190	8000	
3	Video Wall 03	Embedded multiDecoder	172.6.22.190	8000	
4	Video Wall 04	Embedded multiDecoder	172.6.22.190	8000	

Total 4 Items Page 1/1 To 1 P

Figure 7.30 Video Wall/Scene Setting

- 2) Tap the icon to edit the video wall/scene No..

Output Settings -- Video Wall/Scene No

Scene No.: (Range from 1 to 999999)

Name:

Device Name:

IP Address:

Port:

OK

Figure 7.31 Edit Video Wall/Scene

7.2.5 AUX Functions

Steps:

1. Tap the **Aux Key** on the left navigation bar to enter the **Aux Key Settings** interface:

Aux Key

Aux Key 1:

Aux Key 2:

Save

Figure 7.32 Aux Key Settings

2. On this interface, you can set the function of Aux Key 1 / Aux Key 2 to two-way audio, picture capture, or video wall/scene switch.

7.2.6 Network Performance Settings

Steps:

1. Tap **Performance** on the left navigation bar to enter the **Network Performance Settings** interface.
2. Set the network performance of local live view on keyboard. Five levels are selectable.



Figure 7.33 Network Performance Settings

7.2.7 FTP Server Settings

Steps:

1. Tap **FTP Setting** on the left navigation bar to enter the **FTP Settings** interface.

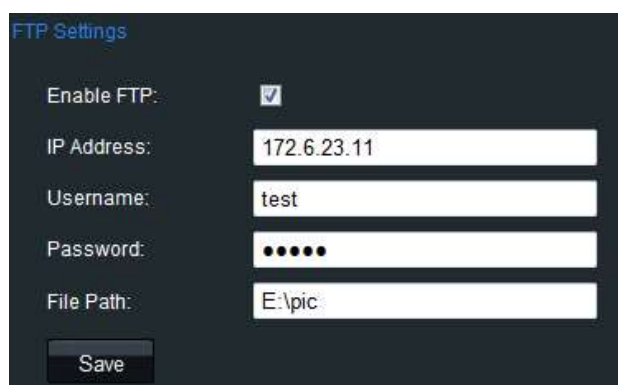

Figure 7.34 FTP Settings

2. Check the checkbox of **Enable FTP**.
3. Input the IP address of the FTP server.
4. Input the user name and password of login to the FTP server.
5. Input the file path to which the video files and captured pictures are uploaded.
6. Tap Save to save the settings.

Appendix A Upgrade by FTP

Enable the FTP service on PC and operate the following steps:

Steps:

1. Open the wftp software, and then select Security->Users/rights option.



2. Create new user.



3. Input the user name: *target*, password: *target*, and then tap **OK** to continue.



4. Select the user name to *target*.



5. Input the directory of the upgrade file in the text box of Home Directory, and then tap **Done** to start system upgrading.

0301001080606d

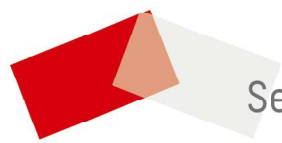

See Far, Go Further