

[Click here for our official COVID-19 statement.](#)



## About this manual

This user manual describes several products. This means you may find instructions that aren't applicable to your product.

## Product overview

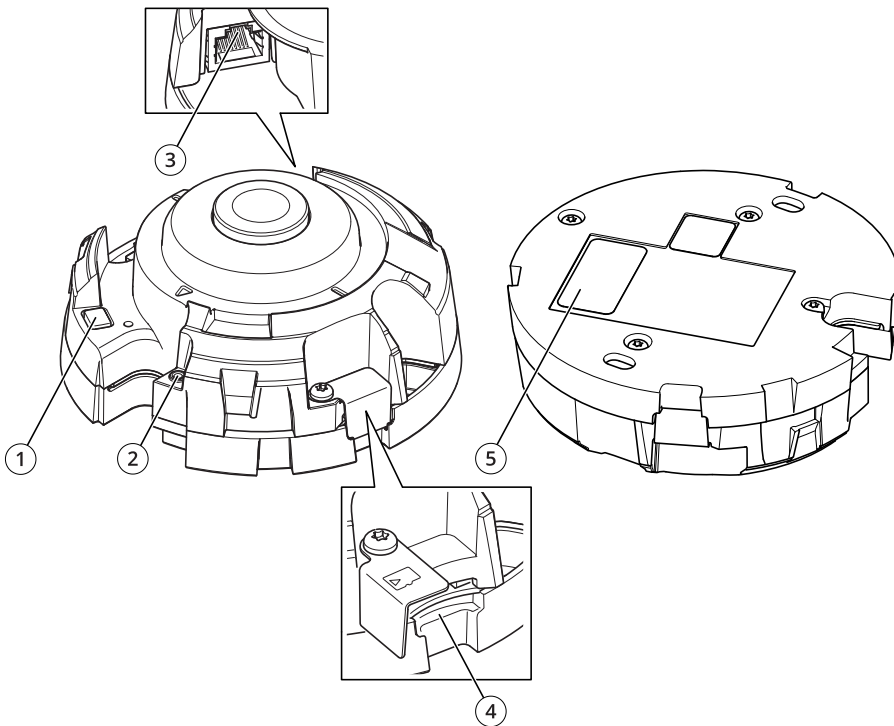

1. *Control button*
2. *Status LED indicator*
3. *Network connector (PoE)*
4. *SD card slot*
5. *Part number (P/N) & Serial number (S/N)*

## Find the device on the network

To find Axis devices on the network and assign them IP addresses in Windows®, use AXIS IP Utility or AXIS Device Manager. Both applications are free and can be downloaded from [axis.com/support](https://axis.com/support).

For more information about how to find and assign IP addresses, see the document *How to assign an IP address and access your device* on the device page at axis.com.

## Browser support

You can use the device with the following browsers:

	Chrome™	Firefox®	Edge®	Safari®
Windows®	recommended	x	x	
OS X®	recommended			x
Other operating systems	x	x		

If you need more information about recommended browsers, go to [axis.com/browser-support](https://axis.com/browser-support).

Feedback

## Access the device

1. Open a browser and enter the IP address or host name of the Axis device.  
If you have a Mac computer (OS X), go to Safari, click Bonjour and select the device from the drop-down list. To add Bonjour as a browser bookmark, go to **Safari > Preferences**.

If you do not know the IP address, use AXIS IP Utility or AXIS Device Manager to find the device on the network.

2. Enter the username and password. If you access the device for the first time, you must set the root password. See [Set a new password for the root account](#).
3. The live view page opens in your browser.

## Set a new password for the root account

### Important

The default administrator username is **root**. If the password for root is lost, reset the device to factory default settings.

1. Type a password. Follow the instructions about secure passwords. See [Secure passwords](#).
2. Retype the password to confirm the spelling.
3. Click **Create login**. The password has now been configured.

## Secure passwords

## Important

Axis devices send the initially set password in clear text over the network. To protect your device after the first login, set up a secure and encrypted HTTPS connection and then change the password.

The device password is the primary protection for your data and services. Axis devices do not impose a password policy as they may be used in various types of installations.

To protect your data we strongly recommend that you:

- Use a password with at least 8 characters, preferably created by a password generator.
- Don't expose the password.
- Change the password at a recurring interval, at least once a year.

## Webpage overview



1. Live view control bar
2. Live view
3. Product name
4. User information, color themes, and help
5. Video control bar
6. Settings toggle

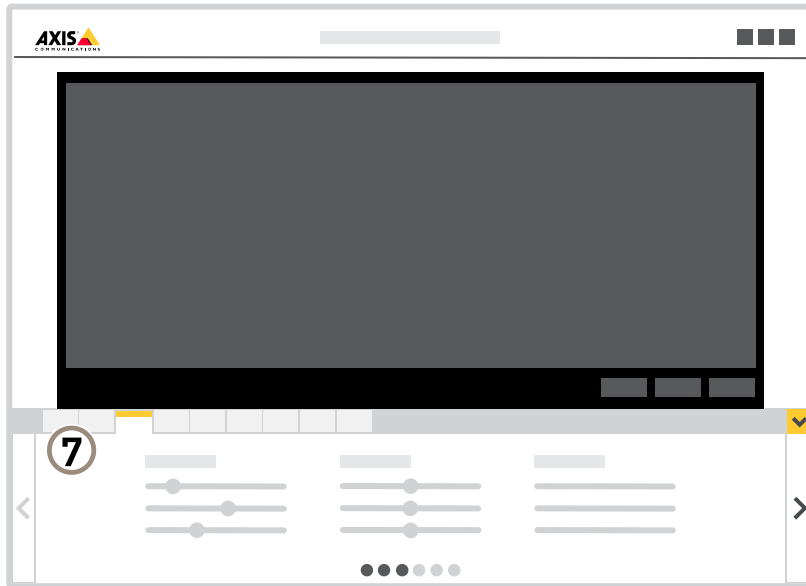

## 7. Settings tabs

# Additional settings

## Adjust the image

If you want to know more about different image settings, see [Learn more](#).

### Rotate image (Digital roll)

To rotate the 360° view, go to **System > Orientation** and use the slider.

You can also use the text field to change the roll angle.

#### Note

All views will be affected when you rotate the image.

### Configure Quad view

1. Select **Quad view** among the live feed sources.
2. Go to **Settings > System > Orientation** and click .
3. Change the view order by drag and drop the yellow boxes.

#### Note

Quad view is available in these mounting modes:







- Desk
- Ceiling

## About capture modes



A capture mode is one of the possible views for this product and can be accessed from the drop-down list in the product's live stream view.

### Note

Selecting capture mode **"360° overview only @ 60/50 fps no WDR"** on AXIS M3067-P and capture mode **"360° overview only @ 30/25 fps no WDR"** on AXIS M3068-P, there will be only Overview available. For the other capture modes see the tables below for supported views/resolutions.

View	Symbol	Aspect ratio	Resolutions M3067-P	Resolutions M3068-P
Overview		1:1	2016x2016 to 160x160	2880x2880 to 160x160
Panorama		8:3 16:9 32:9	2560x960 to 192x72 2560x1440 to 256x144 2560x720 to 1280x360	3584x1344 to 192x72 3840x2160 to 256x144 3584x1008 to 128x360
Double Panorama		4:3 16:9	2560x1920 to 256x192 2560x1440 to 512x288	3584x2668 to 384x288 3584x2016 to 512x288
Quad View		4:3 16:9	2560x1920 to 256x192 2560x1440 to 512x288	3584x2668 to 384x288 3584x2016 to 512x288
View Areas 1-4		4:3 16:9	1920x1440 to 320x240 1920x1080 to 256x144	2048x1536 to 320x240 2048x1152 to 256x144
Corner Left/Right		8:3 2:1	2304x864 to 192x72 2368x1184	3200x1200 to 192x72 3200x1600 to 2400x1200

Feedback

<b>Double Corner</b>		4:3 1:1	1920x1440 to 256x192 2016x2016 to 480x480	2560x1920 to 384x288 2880x2880 to 480x480
<b>Corridor</b>		4:3 16:9	2560x1920 to 320x240 2560x1440 to 256x144	2560x1920 to 320x240 2560x1440 to 256x144

## Select capture mode

Which capture mode to choose depends on the requirements of frame rate and resolution for the specific surveillance setup. For specifications about available capture modes, see the product's datasheet. To find the latest version of the datasheet, go to [axis.com](https://axis.com).

## Select exposure mode

There are different exposure mode options in the camera that adjusts aperture, shutter speed, and gain to improve image quality for specific surveillance scenes. Go to **Settings > Image > Exposure** and select between the following exposure modes:

- For most use cases, select **Automatic** exposure.
- For environments with certain artificial lighting, for example fluorescent lighting, select **Flicker-free**.  
Select the same frequency as the power line frequency.
- For environments with certain artificial light and bright light, for example outdoors with fluorescent lighting at night and sun during daytime, select **Flicker-reduced**.  
Select the same frequency as the power line frequency.
- To lock the current exposure settings, select **Hold current**.

## Reduce noise in low-light conditions

To reduce noise in low-light conditions, you can adjust one or more of the following settings:

- Set the exposure mode to automatic.

### Note

A high max shutter value can result in motion blur.

- To slow down the shutter speed, set max shutter to the highest possible value.
- Reduce sharpness in the image.

## Reduce motion blur in low-light conditions

To reduce motion blur in low-light conditions, adjust one or more of the following settings in **Settings > Image > Exposure**:

- Move the **Blur-noise trade-off** slider toward **Low motion blur**.

### Note

When you increase the gain, image noise also increases.

- Set **Max shutter** to a shorter time, and **Max gain** to a higher value.

If you still have problems with motion blur:

- Increase the light level in the scene.
- Mount the camera so that objects move toward it or away from it rather than sideways.

## Maximize details in an image

### Important

If you maximize details in an image, the bitrate will probably increase and you might get a reduced frame rate.

- Set the compression as low as possible.
- Select MJPEG streaming.
- Turn off Zipstream functionality.

Feedback

## Handle scenes with strong backlight

Dynamic range is the difference in light levels in an image. In some cases the difference between the darkest and the brightest areas can be significant. The result is often an image where either the dark or the bright areas are visible. Wide dynamic range (WDR) makes both dark and bright areas of the image visible.



*Image without WDR.*



Image with WDR.

## Note

WDR might cause artifacts in the image.

1. Go to **Settings > Image > Wide dynamic range**.
2. Turn on WDR.
3. If you still have problems, go to **Exposure** and adjust the **Exposure zone** to cover the area of interest.

Find out more about WDR and how to use it at [axis.com/web-articles/wdr](https://axis.com/web-articles/wdr).

## Hide parts of the image with privacy masks

You can create one or several privacy masks to hide parts of the image.

1. Go to **Settings > Privacy mask**.
2. Click **New**.
3. Adjust the size, color, and name of the privacy mask according to your needs.

## Show an image overlay

To add an image as an overlay in the video stream:

## Show a text overlay in the video stream when the device detects motion

This example explains how to display the text “Motion detected” when the device detects motion:

Make sure that AXIS Video Motion Detection is running:

1. Go to **Settings > Apps > AXIS Video Motion Detection**.
2. Start the application if it is not already running.
3. Make sure you have set up the application according to your needs.

Add the overlay text:

4. Go to **Settings > Overlay**.
5. Enter #D in the text field.
6. Choose text size and appearance.



Create a rule:

7. Go to **System > Events > Rules** and add a rule.
8. Type a name for the rule.
9. In the list of conditions, select **AXIS Video Motion Detection**.
10. In the list of actions, select **Use overlay text**.
11. Select a view area.
12. Type "Motion detected".
13. Set the duration.
14. Click **Save**.

## Show the pan or tilt position as a text overlay

You can show the pan or tilt position as an overlay in the image.

1. Go to **Settings > Overlay** and click **Create overlay**.
2. Select **Text** and click **Create**.
3. In the text field, type #x to show the pan position.  
Type #y to show the tilt position.
4. Choose appearance, text size, and alignment.
5. **Include** the text overlay.
6. The current pan and tilt positions show up in the live view image and in the recording.

Feedback

## View and record video

To learn more about settings for viewing and recording video, see Streaming and storage.

## Reduce bandwidth and storage

### Important

If you reduce the bandwidth it can result in loss of details in the picture.

1. Go to live view and select **H.264**.
2. Go to **Settings > Stream**.
3. Do one or more of the following:
  - Turn on the Zipstream functionality and select the desired level.

### Note

The zipstream settings are used for both H.264 and H.265.

- Turn on dynamic GOP and set a high GOP length value.
- Increase the compression.
- Turn on dynamic FPS.

## Note

Web browsers do not support H.265 decoding. Use a video management system or application supporting H.265 decoding.

## Set up network storage

To store recordings on the network, you need to set up network storage:

1. Go to **Settings > System > Storage**.
2. Click **Setup** under **Network storage**.
3. Enter the IP address of the host server.
4. Enter the name of the shared location on the host server.
5. Move the switch if the share requires a login, and enter username and password.
6. Click **Connect**.

## Record and watch video

To record video you must first set up network storage, see Set up network storage, or have an SD card installed.

### Record video

1. Go to the camera's live view.
2. To start a recording, click **Record**. Click again to stop the recording.

### Watch video

1. Click **Storage > Go to recordings**.
2. Select your recording in the list and it will play automatically.

## Set up rules and alerts

You can create rules to make your device perform an action when certain events occur. A rule consists of conditions and actions. The conditions can be used to trigger the actions. For example, the device can start a recording or send an email when it detects motion, or show an overlay text when it records.

### Trigger an action

1. Go to **Settings > System > Events** to set up a rule. The rule defines when the camera will perform certain actions. Rules can be setup as scheduled, recurring, or for example, triggered by motion detection.
2. Select the **Condition** that must be met to trigger the action. If you specify more than one condition for the rule, all of the conditions must be met to trigger the action.
3. Select which **Action** the camera should perform when the conditions are met.

## Note

If you make changes to an active rule, then the rule needs to be restarted for the changes to take effect.

## Record video when the camera detects motion

This example explains how to set up the camera to start recording to the SD card five seconds before it detects motion and to stop one minute after.

Make sure that AXIS Video Motion Detection is running:

1. Go to **Settings > Apps > AXIS Video Motion Detection**.
2. Start the application if it is not already running.
3. Make sure you have set up the application according to your needs.

Create a rule:

1. Go to **Settings > System > Events** and add a rule.
2. Type a name for the rule.
3. In the list of conditions, under **Application**, select **AXIS Video Motion Detection (VMD)**.
4. In the list of actions, under **Recordings**, select **Record video while the rule is active**.
5. Select an existing stream profile or create a new one.
6. Set the prebuffer time to 5 seconds.
7. Set the postbuffer time to 60 seconds.
8. In the list of storage options, select **SD card**.
9. Click **Save**.

Feedback

## Send an email automatically if someone spray paints the lens

1. Go to **Settings > System > Detectors**.
2. Turn on **Trigger on dark images**. This will trigger an alarm if the lens is sprayed, covered, or rendered severely out of focus.
3. Set a duration for **Trigger after**. The value indicates the time that must pass before an email is sent.

Create a rule:

1. Go to **Settings > System > Events > Rules** and add a rule.
2. Type a name for the rule.
3. In the list of conditions, select **Tampering**.
4. In the list of actions, select **Send notification to email**.
5. Select a recipient from the list or go to **Recipients** to create a new recipient.  
To create a new recipient, click  . To copy an existing recipient, click  .
6. Type a subject and a message for the email.
7. Click **Save**.

# Learn more

## Cleaning recommendations

### NOTICE

Never use harsh detergent, for example gasoline, benzene, or acetone.

1. Use a can of compressed air to remove any dust or loose dirt from the device.
2. If necessary, clean the lens with a soft cloth dampened with lukewarm water.

### Note

Avoid cleaning in direct sunlight or at elevated temperatures, as this may cause stains when the water droplets dry.

## Privacy masks

A privacy mask is a user-defined area that prevents users from viewing a part of the monitored area. In the video stream, privacy masks appear as blocks of solid color.

You'll see the privacy mask on all snapshots, recorded video, and live streams.

You can use the VAPIX® application programming interface (API) to turn off the privacy masks.

### Important

If you use multiple privacy masks it may affect the product's performance.

### Note

Privacy masks may appear warped in some view modes.

## Overlays

Overlays are superimposed over the video stream. They are used to provide extra information during recordings, such as a timestamp, or during product installation and configuration. You can add either text or an image.

## Pan, tilt, and zoom (PTZ)

### Note

The PTZ functionality is only available in the dewarped views: Digital PTZ of view areas, digital PTZ of panorama, corner, corridor and quad views.

## Guard tours

A guard tour displays the video stream from different preset positions either in a predetermined or random order, and for configurable periods of time. Once started, a guard tour continues to run until stopped, even when there are no clients (web browsers) viewing the images.

## Streaming and storage

### Video compression formats

Decide which compression method to use based on your viewing requirements, and on the properties of your network. The available options are:

#### Motion JPEG

Motion JPEG, or MJPEG, is a digital video sequence that is made up of a series of individual JPEG images. These images are then displayed and updated at a rate sufficient to create a stream that shows constantly updated motion. For the viewer to perceive motion video the rate must be at least 16 image frames per second. Full motion video is perceived at 30 (NTSC) or 25 (PAL) frames per second.

Feedback

The Motion JPEG stream uses considerable amounts of bandwidth, but provides excellent image quality and access to every image contained in the stream.

#### H.264 or MPEG-4 Part 10/AVC

##### Note

H.264 is a licensed technology. The Axis product includes one H.264 viewing client license. To install additional unlicensed copies of the client is prohibited. To purchase additional licenses, contact your Axis reseller.

H.264 can, without compromising image quality, reduce the size of a digital video file by more than 80% compared to the Motion JPEG format and by as much as 50% compared to the MPEG-4 standard. This means that less network bandwidth and storage space are required for a video file. Or seen another way, higher video quality can be achieved for a given bitrate.

#### H.265 or MPEG-H Part 2/HEVC

##### Note

H.265 is licensed technology. The Axis product includes one H.265 viewing client license. To install additional unlicensed copies of the client is prohibited. To purchase additional licenses, contact your Axis reseller.

## How do Image, Stream, and Stream profile settings relate to each other?

The **Image** tab contains camera settings that affect all video streams from the product. If you change something in this tab, it immediately affects all video streams and recordings.

The **Stream** tab contains settings for video streams. You get these settings if you request a video stream from the product and don't specify for example resolution, or frame rate. When you change the settings in the **Stream** tab, it doesn't affect ongoing streams, but it will take effect when you start a new stream.

The **Stream profiles** settings override the settings from the **Stream** tab. If you request a stream with a specific stream profile, the stream contains the settings of that profile. If you request a stream without specifying a stream profile, or request a stream profile that doesn't exist in the product, the stream contains the settings from the **Stream** tab.

### Note

When you add a new stream profile for a fisheye camera, make sure that the format and resolution are supported for the selected view, see About capture modes.

## Bitrate control

With bitrate control, you can manage the bandwidth consumption of your video stream.

### Variable bitrate (VBR)

With variable bitrate, the bandwidth consumption varies based on the level of activity in the scene. The more activity in the scene, the more bandwidth you need. You are guaranteed constant image quality but it requires storage margins.

### Maximum bitrate (MBR)

With maximum bitrate, you can set a target bitrate to handle bitrate limitations in your system. You may see a decline in image quality or frame rate when the instantaneous bitrate is kept below the specified target bitrate. You can choose to either prioritize image quality or frame rate. We recommend that you configure the target bitrate to a higher value than the expected bitrate. This gives you a margin for additional complexity that needs to be captured.

## 1. Target bitrate

### Average bitrate (ABR)

With average bitrate, the bitrate is automatically adjusted over a longer timescale. This is so you can meet the specified target and provide the best video quality based on your available storage. Bitrate is higher in scenes with a lot of activity, compared to static scenes. You are more likely to get better image quality when needed when using the average bitrate option. You can define the total storage required to store the video stream for a specified amount of time (retention time) when image quality is adjusted to meet the specified target bitrate. Specify the average bitrate settings in one of the following ways:

- To calculate the estimated storage need, set the target bitrate and the retention time.
- To calculate the average bitrate, based on available storage and required retention time, use the target bitrate calculator.

Feedback

#### 1. Target bitrate

#### 2. Actual average bitrate

You can also turn on maximum bitrate and specify a target bitrate within the average bitrate option.

#### 1. Target bitrate

## 2. Actual average bitrate

# Applications

AXIS Camera Application Platform (ACAP) is an open platform that enables third parties to develop analytics and other applications for Axis products. To find out more about available applications, downloads, trials and licenses, go to [axis.com/applications](https://axis.com/applications).

To find the user manuals for Axis applications, go to [axis.com](https://axis.com).

### Note

- Several applications can run at the same time but some applications might not be compatible with each other. Certain combinations of applications might require too much processing power or memory resources when run in parallel. Verify that the applications work together before deployment.

# Troubleshooting

If you can't find what you're looking for here, try the troubleshooting section at [axis.com/support](https://axis.com/support).

Feedback

# Reset to factory default settings

### Important

Reset to factory default should be used with caution. A reset to factory default resets all settings, including the IP address, to the factory default values.

To reset the product to the factory default settings:

1. Disconnect power from the product.
2. Press and hold the control button while reconnecting power. See Product overview.
3. Keep the control button pressed for 15–30 seconds until the status LED indicator flashes amber.
4. Release the control button. The process is complete when the status LED indicator turns green. The product has been reset to the factory default settings. If no DHCP server is available on the network, the default IP address is `192.168.0.90`.
5. Use the installation and management software tools to assign an IP address, set the password, and access the video stream.  
The installation and management software tools are available from the support pages on [axis.com/support](https://axis.com/support).

It is also possible to reset parameters to factory default through the web interface. Go to **Settings > System > Maintenance** and click **Default**.



## Firmware options

Axis offers product firmware management according to either the active track or the long-term support (LTS) tracks. Being on the active track means continuously getting access to all the latest product features, while the LTS tracks provide a fixed platform with periodic releases focused mainly on bug fixes and security updates.

Using firmware from the active track is recommended if you want to access the newest features, or if you use Axis end-to-end system offerings. The LTS tracks are recommended if you use third-party integrations, which are not continuously validated against the latest active track. With LTS, the products can maintain cybersecurity without introducing any significant functional changes or affecting any existing integrations. For more detailed information about Axis product firmware strategy, go to [axis.com/support/firmware](https://axis.com/support/firmware).

## Check the current firmware

Firmware is the software that determines the functionality of network devices. One of your first actions when troubleshooting a problem should be to check the current firmware version. The latest version may contain a correction that fixes your particular problem.

Feedback

To check the current firmware:

1. Go to the product's webpage.
2. Click on the help menu .
3. Click **About**.

## Upgrade the firmware

### Important

Preconfigured and customized settings are saved when the firmware is upgraded (provided that the features are available in the new firmware) although this is not guaranteed by Axis Communications AB.

### Important

Make sure the product remains connected to the power source throughout the upgrade process.

### Note

When you upgrade the product with the latest firmware in the active track, the product receives the latest functionality available. Always read the upgrade instructions and release notes available with each new release before upgrading the firmware. To find the latest firmware and the release notes, go to [axis.com/support/firmware](https://axis.com/support/firmware).

1. Download the firmware file to your computer, available free of charge at [axis.com/support/firmware](https://axis.com/support/firmware).

2. Log in to the product as an administrator.
3. Go to **Settings > System > Maintenance**. Follow the instructions on the page. When the upgrade has finished, the product restarts automatically.

AXIS Device Manager can be used for multiple upgrades. Find out more at [axis.com/products/axis-device-manager](https://axis.com/products/axis-device-manager).

## Technical issues, clues and solutions

If you can't find what you're looking for here, try the troubleshooting section at [axis.com/support](https://axis.com/support).

---

### Problems upgrading the firmware

**Firmware upgrade failure** If the firmware upgrade fails, the device reloads the previous firmware. The most common reason is that the wrong firmware file has been uploaded. Check that the name of the firmware file corresponds to your device and try again.

---

### Problems setting the IP address

**The device is located on a different subnet** If the IP address intended for the device and the IP address of the computer used to access the device are located on different subnets, you cannot set the IP address. Contact your network administrator to obtain an IP address.

**The IP address is being used by another device** Disconnect the Axis device from the network. Run the ping command (in a Command/DOS window, type `ping` and the IP address of the device):

- If you receive: Reply from <IP address>: bytes=32; time=10... this means that the IP address may already be in use by another device on the network. Obtain a new IP address from the network administrator and reinstall the device.
- If you receive: Request timed out, this means that the IP address is available for use with the Axis device. Check all cabling and reinstall the device.

**Possible IP address conflict with another device on the same subnet** The static IP address in the Axis device is used before the DHCP server sets a dynamic address. This means that if the same default static IP address is also used by another device, there may be problems accessing the device.

---

### The device cannot be accessed from a browser

Cannot log in

When HTTPS is enabled, ensure that the correct protocol (HTTP or HTTPS) is used when attempting to log in. You may need to manually type `http` or `https` in the browser's address field.

If the password for the user `root` is lost, the device must be reset to the factory default settings. See [Reset to factory default settings](#).

The IP address has been changed by DHCP

IP addresses obtained from a DHCP server are dynamic and may change. If the IP address has been changed, use [AXIS IP Utility](#) or [AXIS Device Manager](#) to locate the device on the network. Identify the device using its model or serial number, or by the DNS name (if the name has been configured).

If required, a static IP address can be assigned manually. For instructions, go to [axis.com/support](https://axis.com/support).

Certificate error when using IEEE 802.1X

For authentication to work properly, the date and time settings in the Axis device must be synchronized with an NTP server. Go to **Settings > System > Date and time**.

Feedback

## The device is accessible locally but not externally

To access the device externally, we recommend using one of the following applications for Windows®:

- [AXIS Companion](#): free of charge, ideal for small systems with basic surveillance needs.
- [AXIS Camera Station](#): 30-day trial version free of charge, ideal for small to mid-size systems.

For instructions and download, go to [axis.com/vms](https://axis.com/vms).

## Problems with streaming

Multicast H.264 only accessible by local clients

Check if your router supports multicasting, or if the router settings between the client and the device need to be configured. The TTL (Time To Live) value may need to be increased.

No multicast H.264 displayed in the client

Check with your network administrator that the multicast addresses used by the Axis device are valid for your network.

Check with your network administrator to see if there is a firewall preventing viewing.

Poor rendering of H.264 images

Ensure that your graphics card is using the latest driver. The latest drivers can usually be downloaded from the manufacturer's website.

Color saturation is different in H.264 and Motion JPEG

Modify the settings for your graphics adapter. Go to the adapter's documentation for more information.

Lower frame rate than expected

- See Performance considerations.
- Reduce the number of applications running on the client computer.
- Limit the number of simultaneous viewers.
- Check with the network administrator that there is enough bandwidth available.
- Lower the image resolution.
- The maximum frames per second is dependent on the utility frequency (60/50 Hz) of the Axis device.

Can't select H.265 encoding in live view

Web browsers do not support H.265 decoding. Use a video management system or application supporting H.265 decoding.

Feedback

## Performance considerations

When setting up your system, it is important to consider how various settings and situations affect the performance. Some factors affect the amount of bandwidth (the bitrate) required, others can affect the frame rate, and some affect both. If the load on the CPU reaches its maximum, this also affects the frame rate.

The following factors are the most important to consider:

- High image resolution or lower compression levels result in images containing more data which in turn affects the bandwidth.
- Rotating the image in the GUI will increase the product's CPU load.
- Access by large numbers of Motion JPEG or unicast H.264 clients affects the bandwidth.
- Simultaneous viewing of different streams (resolution, compression) by different clients affects both frame rate and bandwidth.  
Use identical streams wherever possible to maintain a high frame rate. Stream profiles can be used to ensure that streams are identical.
- Accessing Motion JPEG and H.264 video streams simultaneously affects both frame rate and bandwidth.
- Heavy usage of event settings affects the product's CPU load which in turn affects the frame rate.
- Using HTTPS may reduce frame rate, in particular if streaming Motion JPEG.
- Heavy network utilization due to poor infrastructure affects the bandwidth.
- Viewing on poorly performing client computers lowers perceived performance and affects frame rate.

- Running multiple AXIS Camera Application Platform (ACAP) applications simultaneously may affect the frame rate and the general performance.

## Need more help?

### Useful links

- [How to assign an IP address and access your device](#)

### Contact support

Contact support at [axis.com/support](https://axis.com/support).

## Specifications

To find the latest version of the product's datasheet, go to the product page at [axis.com](https://axis.com) and locate **Support & Documentation**.

Feedback

## LED indicators

### Note

The Status LED can be configured to flash while an event is active.

Status LED	Indication
Unlit	Connection and normal operation.
Green	Shows steady green for 10 seconds for normal operation after startup completed.
Amber	Steady during startup. Flashes during firmware upgrade or reset to factory default.
Amber/Red	Flashes amber/red if network connection is unavailable or lost.
Red	Firmware upgrade failure.

## SD card slot

### NOTICE

- Risk of damage to SD card. Do not use sharp tools, metal objects, or excessive force when inserting or removing the SD card. Use your fingers to insert and remove the card.
- Risk of data loss and corrupted recordings. Do not remove the SD card while the product is running. Unmount the SD card from the product's webpage before removal.

This product supports microSD/microSDHC/microSDXC cards.

For SD card recommendations, see [axis.com](https://axis.com).

microSD, microSDHC, and microSDXC Logos are trademarks of SD-3C LLC. microSD, microSDHC, microSDXC are trademarks or registered trademarks of SD-3C, LLC in the United States, other countries or both.

## Buttons

### Control button

The control button is used for:

- Resetting the product to factory default settings. See [Reset to factory default settings](#).

## Connectors

### Network connector

RJ45 Ethernet connector with Power over Ethernet (PoE).