

# DH-PFA111

## Mount Adapter



### Features

- Aesthetic design
- Material: aluminum
- Mount adapter

### Technical Specifications

<b>Model</b>	<b>DH-PFA111</b>
<b>General</b>	
Material	Aluminum
Dimension	Φ60mmx49mm (Φ2.36"x1.93")
Pipe Thread	G1 1/2"
Load Bearing	7.0kg(15.43lb)
Weight	0.25kg(0.55lb)
Color	White
Operating Temperature	-40°C ~ +60°C (-40°F ~ +140°F)
Humidity	<90% RH
Applicable Model	Please see "Accessory Selection"

### Order Information

Type	Part Number	Description
Camera Mount	DH-PFA111	Mount adapter
	PFA111	Mount adapter

### Dimensions (mm/inch)

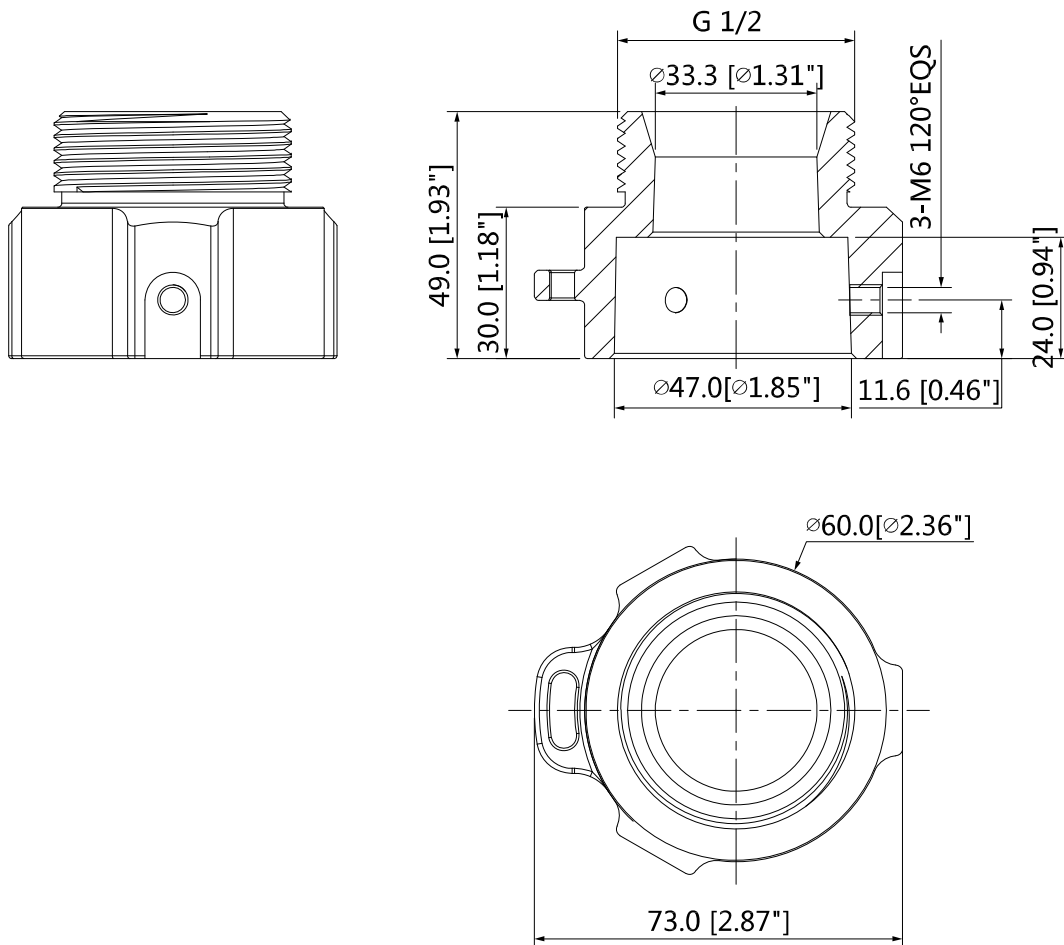

## Application

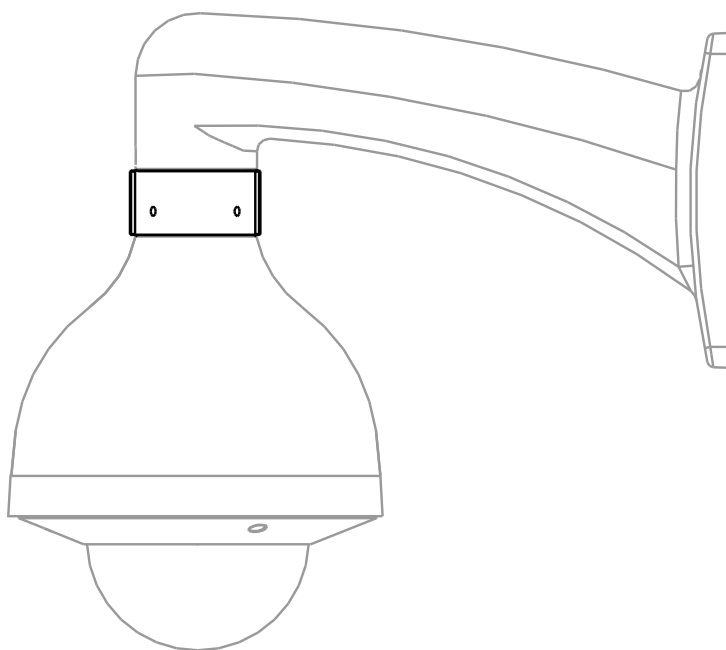

## Package Information

- Mount adapter \*1